



---

# General Pipeline System Setup Information

---

Because of Pipeline's unique network attached architecture it is important to understand each component of a Pipeline system in order to create a system that will meet the needs of your workflow.

## Pipeline system architecture

Pipeline is a unique network attached encoder system that can be used in a variety of capture and playout workflows. Being network attached there are several architectural constraints that need to be understood in order to configure an efficient and reliable Pipeline system.

Pipeline system capture workflows consists of taking baseband HD/SD-SDI inputs, compressing it, creating a file with the compressed data and delivering the completed file to a folder location. The Pipeline system will consists of one or more Pipeline network attached encoder devices connected via CAT6 Ethernet to a Pipeline host computer.

Pipeline network attached encoder devices should be connected directly via CAT6 Ethernet to a Pipeline host computer or via a fully non-blocking managed Layer 2/3 Enterprise Edge Ethernet switch with adequate per-port data buffering.

## Pipeline System

Because of Pipeline's unique network attached architecture it is important to understand each component of a Pipeline system in order to create a system that will meet the needs of your workflow.

A Pipeline System consists of one or more Pipeline channels and a Pipeline host computer (Mac or Windows PC) connected together via Ethernet wiring.

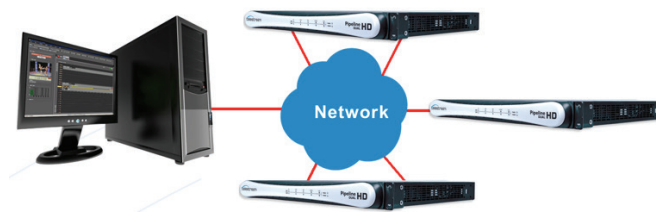

The key components of a Pipeline System are the Pipeline device hardware, Pipeline network, the Pipeline host hardware, the Pipeline application software and the Pipeline media disk storage systems. Each of these components is described below.

### Pipeline device hardware

*Pipeline device hardware* has up to four independent channels with SDI I/O for capture and play out. The SDI connectors take baseband SD/HD-SDI signals as input, compress them into one of many supported formats and stream the compress data (video, audio and control data) out their respective Ethernet ports using Real Time Streaming Protocol (RTSP). Each Pipeline channel's RTSP stream contains video, audio and application/control data in RTP transport packets. These Pipeline channel streams are consumed by Pipeline application software running on a Pipeline host computer. The Pipeline application software will wrap each RTSP stream into the appropriate file wrapper and deliver these files to their respective media storage locations.

### Pipeline host and Pipeline application software

The Pipeline host computer is primarily responsible for taking one or more Pipeline channel's RTSP streams via Ethernet, wrapping them in the appropriate format and writing the resulting file to the selected media destination. Pipeline host systems can be Mac OS X or Microsoft Windows based.

**Note:** Pipeline Control software captures data coming from one or more Pipeline channels, and writes this data to disk in real-time. To prevent interference with Pipeline Control any process, such as real-time anti-virus scanning, should be disabled while Pipeline Control is in use. Other processes that periodically run such as operating system updates should also be disabled.

A Pipeline host computer can control multiple Pipeline channels concurrently. Use this document to understand how to configure a Pipeline System to meet your particular needs.

Pipeline software applications perform many tasks. These task range from scheduled capture and play out, log/capture from tape sources, manual and automated capture from live sources and print to tape/play out functions.

There are five components to consider when choosing the Pipeline host system.

- CPU cores and speed (*see System Recommendation section*)
- Networks connection (*see Pipeline Network section*)
- Disk storage systems (*see Pipeline Media Storage section*)
- System RAM (*see System Recommendation section*)
- System Video Card

Use the system descriptions, recommended systems chart, network and storage sections to configure your Pipeline host system.

### Performance tuning of the Pipeline host systems

Perform the following adjustments on the Pipeline host server to assure proper performance (consult with your System Administrator or a Telestream Field Sales Engineer)

#### Windows systems only:

- From within Performance Options set Processor scheduling to – Adjust for best performance of: Programs
  - Disable Network throttling (see <http://support.microsoft.com/kb/948066>)
    - Set value to: FFFFFFFF
  - Turn on Data Execution Prevention (DEP) for essential Windows programs and services only.
  - Disable User Account Control (UAC).
- Set the Pipeline host server's Power Options to High Performance with all critical functions to be always on including the disabling of any disk sleep modes.
- Disable any real-time software applications and processes that could adversely affect disk I/O performance or use excessive CPU. In particular real-time virus scanning of media files as they are being captured, automatic software updates that can preempt real-time services, and real-time file indexing that could consume excessive CPU and disk I/O.
- Disable all unnecessary Windows services from Administrative Tools->Services console (consult your System Administrator)
- Firewalls and packet filtering may result in unpredictable performance and should be avoided
- Use only Intel based enterprise-class Ethernet Server Network Adapters with Advanced Network Services (ANS) installed

- For Pipeline channels that are directly connected to the Pipeline host server's network adapters, disable all Networking Property components except Internet Protocol Version 4 (TCP/IPv4)
- Turn off all power saving options on the Network Adapters used for Pipeline traffic
- Set Network Adapter transmit and receive buffers to 1024
- Use static IP Addresses for all Pipeline channels
- Disable any screensaver functions.

### Pipeline network

For best results Pipeline device hardware should be connected directly to a Pipeline host computer or via a single enterprise class, fully non-blocking professional quality Ethernet switch via CAT6 Ethernet cabling. Multiple hops via routers and switches increase the risk that video frames will not be processed in a timely manner resulting in lost frames. While not absolutely required it is highly recommended that the Pipeline host's network adapter be based on an Intel Gigabit Ethernet controller (82571EB, 82546GB, 82576EB, I340, I350). Only adapters using Intel controllers have been fully tested with multiple Pipeline channel networks. Non-Intel Ethernet adapters embedded on the Pipeline host workstation or server's motherboard should not be used for Pipeline traffic.

### Approved Network adapters for Pipeline HD Dual

Intel based enterprise-class Ethernet Network Server Adapters with Advanced Network Services (ANS) installed.

- Pro/1000 Series (PT, PF, MT, MF, GT, ET or EF)
- I340 or I350 Series

Capturing across multiple switches is possible but should not be done in critical Pipeline production workflows. All switches used for Pipeline traffic must meet the minimum requirements. Always consult with your network administrator when attempting to utilize Pipeline across multiple switches, networks or VLAN's. The use of STATIC IP addresses for each Pipeline channel is required.

- It is required that a fully non-blocking managed Layer 2/3 Enterprise Edge Ethernet switch with adequate per-port data buffering be used. The following switches are highly recommended for Pipeline systems:
  - Extreme Networks Summit X350, X450 and X650, Dell Force10 S60, Arista 7048T
- Use of a private Pipeline video VLAN is highly recommended

Special care must be taken to insure that Pipeline real-time processes can be achieved. To ensure reliable Pipeline performance, Pipeline must be on a dedicated media network. Operating on a general information network will expose Pipeline to network processes that can consume unbounded bandwidth and excessive network stack cycles which can cause Pipeline real-time streams to be interrupted. These interruptions can cause Pipeline to become unstable and stop operating.

- Pipeline Encoders and Pipeline Control host machines should not be connected to a general information network. If operating Pipeline on a general information network the recommended procedure is to reboot Pipeline once per week (every seven days) as part of your standard system maintenance. Not doing this recommended procedure may cause Pipeline to stop operating.
- If Pipeline is operating on a dedicated media network with adequate bandwidth there is no need to perform the recommended weekly reboot procedure.
- The Pipeline Control host machines should be dedicated to running Pipeline Control and should not have other applications or services installed.

Best practice on the Pipeline host system is to separate Pipeline traffic from data traffic by using more than one network adapter within the Pipeline host computer. Design your system with one (or more) Ethernet ports dedicated to the incoming Pipeline streams and separate Ethernet port(s) for general data and media delivery traffic. As a rule of thumb never exceed 50% usage of any one Ethernet port or network switch. For example when capturing Pro Res 422 HQ at 220Mbps use one GigE Ethernet port for every two (2) streams. Multiple port Ethernet cards are required for this purpose.

There are three basic ways to configure a Pipeline network setup; direct attached, network attached, and network attached with LACP (port bonding). Below are simple examples of all three.

**Note:** With all Ethernet interfaces, especially add in cards with more than 2 ports, the physical order of the interface ports may or may not match the order they are presented to the user in the O/S. ALWAYS start by connecting one Pipeline channel at a time to a single port until you are certain which physical interface is which in your operating system. For 'bonded config' (LACP) both switch and host machine must support LACP (port failover should not be enabled)

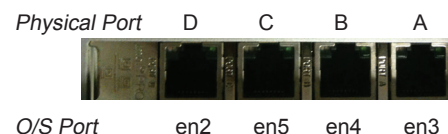

### Pipeline Simple Network Example

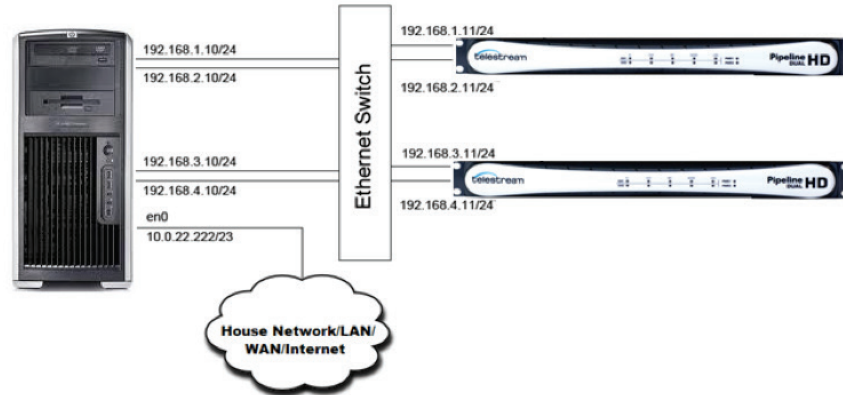

### Pipeline LACP (bonded ports) Network Example

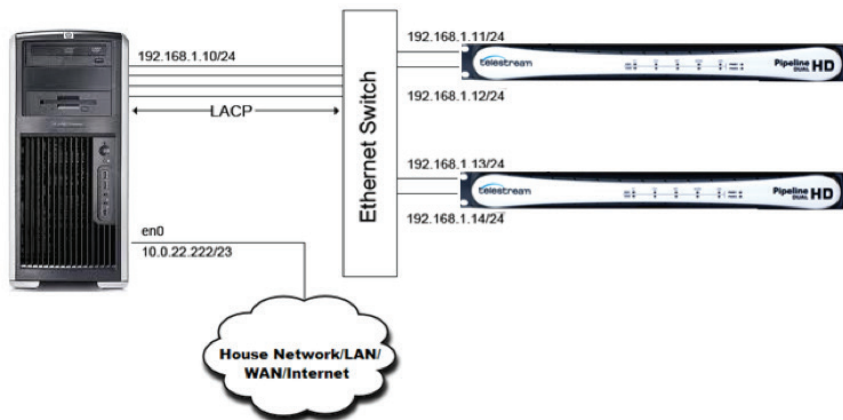

### Pipeline Direct Attached Example

**Warning:** When directly attaching multiple Pipeline channels to the host's network adapter always connect them one at a time and configure each on their own subnet (as shown below).

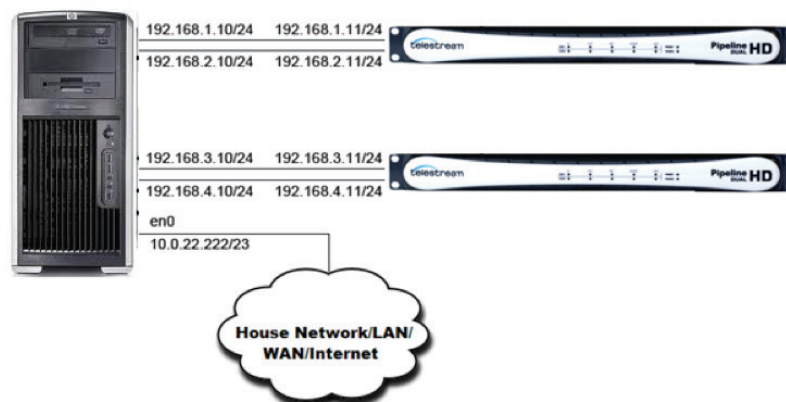

### Pipeline media Storage

When deciding on storage, there are two main factors to consider - the overall sustained read/write performance required and whether local data disk buffering will be required.

To ensure performance and quality, the disk storage system(s) used with the Pipeline host computer must be able to meet the demands of reading and writing one or more real-time SD and HD media streams.

There are many disk system setups that can provide this level of performance.

For SD, we recommend that the Pipeline host's disk storage system provide and maintain a sustained 10 MB/sec transfer rate per stream from the Pipeline host computer to the media disk (read/write).

For DVCPro HD, ProRes 422 and standard quality DNxHD, we recommend that the Pipeline host's disk storage system provide and maintain a sustained 40 MB/sec transfer rate per stream from the Pipeline host computer to media disk (read/write) for each stream. For ProRes 422 HQ and high quality DNxHD, we recommend at least a 50 MB/sec transfer rate for each stream.

To evaluate your needs, you must first take into account the data rate for the format that you'll be using and the number of streams your system will be capturing concurrently. The table below provides approximate data rates for a variety of formats and resolutions. Use these tables to calculate the overall read/write performance requirements for your main storage disk system and if needed for your local data buffering storage disk system.

Using a disk benchmarking tool as ATTO's Bench32 for Windows and DiskFire for OSX make sure the media storage system can accommodate the total bandwidth necessary, both read and write.

**Capture only, writing to internal or direct attached RAID array:** For systems utilizing internal or direct attached storage for capture only operations you need only calculate the overall write speed requirements. Configure your media storage array based on the write performance needed for the number of streams being captured.

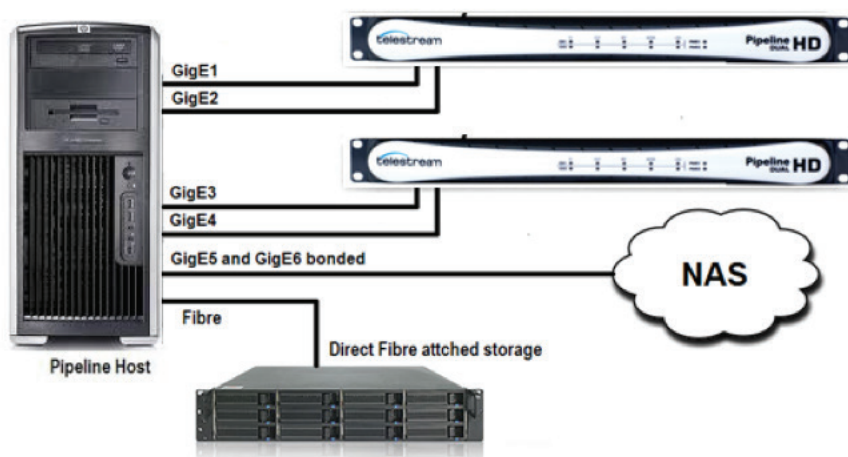

Four (4) channel Pipeline HD with direct attached Fibre RAID storage

**Capture with concurrent edit or transcode:**

For systems that are capturing with concurrent edit or transcode operations you will need to calculate the overall read/write speed requirements based on the write processes of Pipeline streams and read processes for the edit and transcode operations. To guarantee error free operations you must use Pipeline’s data buffering feature utilizing an internal or direct attached non-shared storage RAID array for data buffering that meets the desired read/write performance requirement (see Disk Buffering section below). The Pipeline’s media storage location (NAS, direct attached shared storage or shared network folder) must also meet these minimum read/write performance requirements. When using NAS, direct attached shared storage or shared network folder, be sure to verify that your system has the communications bandwidth for writing all Pipeline media data to the media storage location in real-time.

**Capture writing to NAS or shared network folder:**

For systems that are capturing media that is being written to a NAS or shared network folder, it is required to use the Pipeline data buffering feature (see Disk Buffering section below). Data Buffering requires a separate data buffer RAID array to guarantee error free write operations of Pipeline media streams. Calculating the disk buffer RAID array read/write performance requirements using 2X the required Pipeline stream’s write requirements. This is needed to support a write and a read operation on the data buffer array for each Pipeline stream. The Pipeline’s media storage location (NAS, direct attached shared storage or shared network folder) must meet the minimum write performance requirements. When using NAS or shared network folder, be sure to verify that your system has the communications bandwidth for writing all Pipeline media data to the media storage location in real-time.

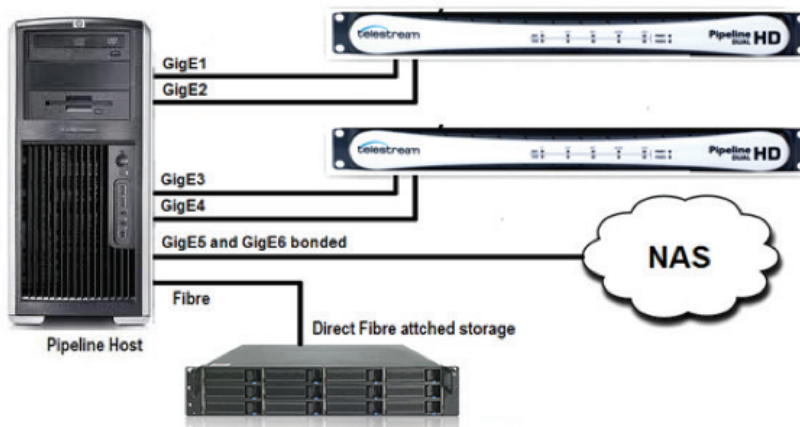

Four (4) channel Pipeline HD with direct attached data buffer RAID

**Caution:** Capturing video is a very disk intensive operation. It is extremely important that you create a system that has adequate disk performance for writing and reading real-time video files. In addition to the information provided in this guide make sure that the disk system used for Pipeline operations are defragmented often and that any disk sleep/stand-by power settings are disabled. Fragmented drives or drives in sleep/stand-by states can dramatically decrease performance and may cause capture or play out operations to fail.

## Example Systems

**Distributed Pipeline model** – individual workstations controlling individual channels. Each workstation meeting the single Pipeline channel spec with a network to support all traffic.

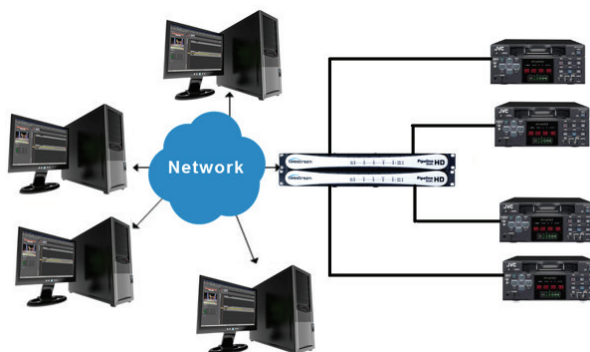

**Multiple channel Transcode while capture** – Multiple Pipeline channels hosted by a central workstation with delivery to a directly attached storage device. The storage is shared to the transcoding servers for concurrent processing.

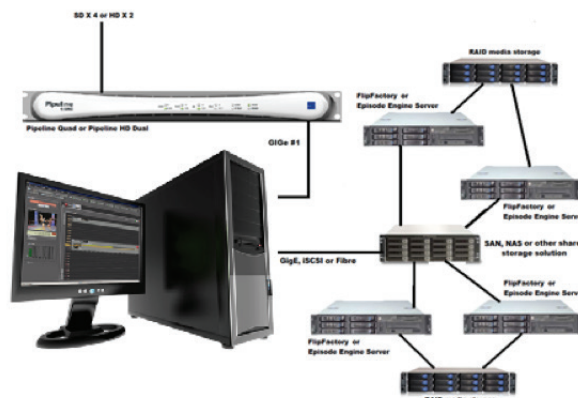

**Centralized Pipeline ingest model** – A central workstation controlling multiple Pipeline channels. The central workstation meets the multiple Pipeline channel spec with a network and storage system to support the workflow.

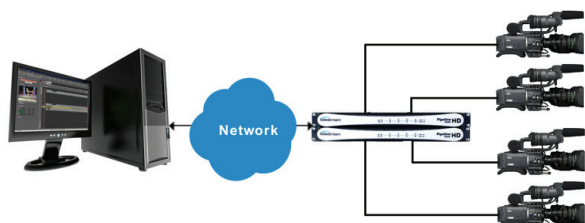

**Multiple channel edit while capture** – Multiple Pipeline channels hosted by a central workstation with delivery to shared storage device. Internal 15K RAID array is used as a Disk Buffer in case the shared storage cannot maintain real time writes.

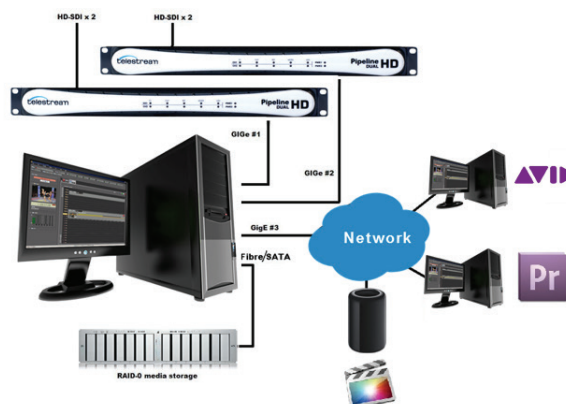

**Four (4) channel HD with data buffering** – Four (4) channels of HD hosted by a central workstation with delivery to a NAS. Data Buffering is enabled through directly attached RAID storage.

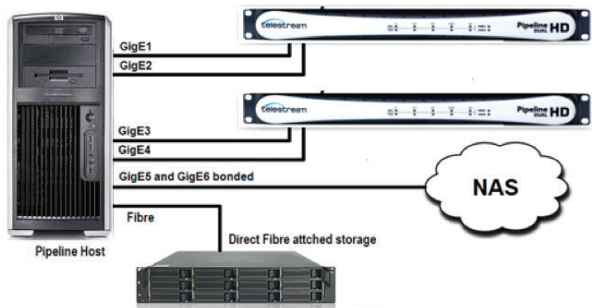

### Using a Pipeline HD Dual and Vantage on a single system

Pipeline HD Dual and Vantage can be installed on the same server in order to create a two (2) channel baseband ingest solution directly integrated with Vantage. This will allow for real-time or near real-time file creation into virtually any format from live or tape sources.

Generally Pipeline Control processes do not use a great deal of CPU resources allowing Vantage workflow processes to utilize the majority of available CPU resources. However close attention must be taken to assure that the Vantage server can meet the Pipeline's CPU, network bandwidth and disk I/O requirements.

Follow the Pipeline configuration and setup procedures as described in this document in order to determine the host system requirements for an integrated two (2) channel Pipeline/Vantage server.

There are five components to consider when choosing a two (2) channel Pipeline/Vantage host system.

- CPU cores and speed (see System Recommendation section)
- Faster is always better

- Network connections (see Pipeline Network section)
  - Separating Pipeline channel traffic from general data traffic by directly attaching each Pipeline channel is required
- Media Disk storage systems (see Pipeline Media Storage section)
  - Disk I/O fast enough to support real-time Pipeline file writing, Vantage file writing and Vantage file reading
- System RAM (see System Recommendation section)
  - Enough RAM to support all Pipeline and Vantage processes
  - 8GB per channel is the general rule
  - More is always better
- System Video Card

Use the system descriptions, recommended systems chart, network and storage sections in this document to configure your Pipeline/Vantage host system.

### Pipeline Host computer recommendations

Network and Hard Disk Performance Requirements (per stream)

CODEC	Disk read/write (MB/s)	Network throughput (Mb/s)	Storage required with 8 channels of audio
SD Codecs			
Motion JPEG A	0.75	8	5GB/hr
DV/DVCPPro	4.4	35	15GB/hr
IMX30	5.3	43	16GB/hr
IMX40	7	56	20GB/hr
IMX50/DVCPPro50	8.3	67	25GB/hr
ProRes 422	7.3	58	21GB/hr
Uncompressed 8bit 422	22	175	80GB/hr
HD Codecs (range based on codec and bit rate)			
DVCPPro HD	16.5	135	73GB/hr
ProRes 422 HQ	10-36	62-240	50-100GB/hr
DNxHD	10-36	62-240	50-100GB/hr



## Systems Recommendations<sup>1</sup>

### General guidelines

- CPU
  - Single/Dual channel - Intel Quad core i7 or equivalent
  - Three/Four channel - Dual Xeon Quad core
  - Five/Six channel - Dual Xeon Six Core
- RAM - 8GB RAM per channel
- Operating System – Windows Server 2008 R2, Windows 7 Pro (64bit recommended) - see the Telestream web site for the latest operating systems supported
- Media Storage sustained read and/or write speeds (separate from OS drive)
  - Capture only – 40MB/s per channel
  - Play out only – 60MB/s per channel
  - Transcode/Edit/Disk Buffering while Capture – 100MB/s per channel

<sup>1</sup> All systems assume media storage local (internal or direct attached) to the host system with adequate storage to support 24 hours of content at the chosen format, and drive array is less than 80% full without serious fragmentation.

*Edit while ingest and transcode while ingest workflows require increased disk I/O performance to support the additional read processes, and may require disk buffer cache drive system (see Pipeline User Guide disk buffering details).*

*Viewing HD preview stream(s) can consume high levels of CPU which may cause dropped frames. It is recommended that preview be turned off during capture.*

