



Pipeline 2.6 User Guide for Windows

Preface

COPYRIGHT AND TRADEMARK NOTICE

Copyright 2015 Telestream, LLC. All rights reserved. No part of this publication may be reproduced, transmitted, transcribed, altered, or translated into any languages without written permission of Telestream, LLC. Information and specifications in this document are subject to change without notice and do not represent a commitment on the part of Telestream.

Telestream, CaptionMaker, Episode, Flip4Mac, FlipFactory, Flip Player, Lightspeed, ScreenFlow, Switch, Vantage, Wirecast, GraphicsFactory, MetaFlip, and Split-and-Stitch are registered trademarks and Pipeline, MacCaption, and e-Captioning are trademarks of Telestream, LLC. All other trademarks are the property of their respective owners.

QuickTime, Mac OS X, Final Cut Pro, and Safari are trademarks of Apple, Inc. Bonjour, the Bonjour logo, and the Bonjour symbol are trademarks of Apple, Inc.



All other brand, product, and company names are property of their respective owners, and are used only for identification purposes.

MPEG-2 License Requirements

Telestream has obtained a license from MPEG LA, to produce MPEG-2 video, to meet the following requirement on behalf of its FlipFactory and Pipeline licensees: The use of this product in any manner that complies with the MPEG-2 standard is expressly prohibited without a license under applicable patents in the MPEG-2 patent portfolio, which license is available from MPEG LA, L.L.C., 250 Steele Street, Suite 300, Denver, Colorado 80206.

Obtaining Pipeline Support | Information | Assistance

Web Site. <http://www.telestream.net/telestream-support/pipeline/support.htm>

Terms and times of support services vary, per the terms of your current service contract with Telestream.

Pipeline Web Site – FAQs, Forums & Updates

Web Site. <http://www.telestream.net/telestream-support/pipeline/support.htm>

Returning Inoperative Pipelines (RMA)

If your Pipeline is inoperative, contact Telestream at the Pipeline support E-mail address provided below, or contact your authorized reseller. Provide your company and contact information, the serial number of the inoperative unit, and request instructions for Return Material Authorization.

Company and Product Information

For information about Telestream or its products, please contact us via:

Web Site. www.telestream.net

Sales and Marketing Email. info@telestream.net

We'd Like to Hear From You!

If you have comments or suggestions about improving this document, other Telestream documents, or our Web site – or if you've discovered an error or omission, please email us at techwriter@telestream.net

Mail

Telestream, LLC.
848 Gold Flat Road, Suite 1
Nevada City, CA. USA 95959

International Telestream Distributors

See the Telestream Web site at www.telestream.net for your regional authorized Telestream distributor.

FCC Emission Information

Ethernet connections to Pipeline devices must be made using a shielded Category 5 or Category 6 cable to ensure emissions are within applicable standards. This equipment has been tested and found to comply with the limits for a Class A digital device, pursuant to Part 15 of the FCC Rules.

These limits are designed to provide reasonable protection against harmful interference when the equipment is operated in a commercial environment. This equipment generates, uses and can radiate radio frequency energy and, if not installed and used in accordance with the instruction manual, may cause harmful interference to radio communications.

Operation of this equipment in a residential area is likely to cause harmful interference with other electronic equipment in which case the user will be required to correct the interference at his/her own expense. Changes or modifications not expressly approved by Telestream can affect emission compliance and could void the user's authority to operate this equipment.

Canadian EMC Notice of Compliance

This digital apparatus does not exceed the Class A limits for radio noise emissions from digital apparatus set out in the Radio Interference Regulations of the Canadian Department of Communications.

Le présent appareil numérique n'émet pas de bruits radioélectriques dépassant les limites applicables aux appareils numériques de la classe A prescrites dans le Règlement sur le brouillage radioélectrique édicté par le Ministère des Communications du Canada.

Important Safety Instructions

Before using Pipeline devices, read the following safety instructions to ensure it is used safely:

- Unplug the device before cleaning.
- Use only a lightly-dampened cloth to clean the unit; never pour liquids onto the device.
- Do not place the device on an unstable surface or near extreme heat.
- Do not stack Pipelines more than two units high to avoid over-heating.
- Use only the power source supplied, and recommended in this manual.
- Connect all electronic equipment to properly grounded power outlets.
- Telestream recommends using surge protection equipment (may be feature of a UPS).



Caution

Pipelines contain no user serviceable parts. Never open the chassis enclosure. Doing so without express permission from Telestream may void your warranty.

EN55022 Class A Warning

In a domestic environment this product may cause radio interference in which case the user may be required to take adequate measures.

Regulatory Approved Standards for Electrical Safety

This equipment complies with the minimum requirements of these standards:

IEC950 (or EN60950/BS7002/VDE0805 May 1990)

UL1950

CSA C22.2-950-M89

Radiation Emission Susceptibility Regulatory Approved Standards

This equipment complies with the minimum requirements of these standards:

FCC155, Class A

EN55022, Class A

EC DIR 89/336/EEC

EN50082-1

Limited Warranty and Disclaimers

Telestream LLC (the Company) warrants to the original registered end user that the product will perform as stated below for a period of one (1) year from the date of shipment from factory:

Hardware and Media. The Product hardware components, including equipment supplied but not manufactured by the Company but NOT including any third party equipment that has been substituted by the Distributor for such equipment (the "Hardware"), will be free from defects in materials and workmanship under normal operating conditions and use.

Software. If software is supplied as part of the product, the software will operate in substantial conformance with specifications set forth in its product user's guide. The Company does not warrant that the software will operate uninterrupted or error-free, will meet your requirements, or that software errors will be corrected.

Warranty Remedies

Your sole remedies under this limited warranty are as follows:

Hardware and Media. The Company will either repair or replace (at its option) any defective Hardware component or part, or Software Media, with new or like new Hardware components or Software Media. Components may not be necessarily the same, but will be of equivalent operation and quality.

Software. If software is supplied as part of the product and it fails to substantially conform to its specifications as stated in the product user's guide, the Company shall, at its own expense, use its best efforts to correct (with due allowance made for the nature and complexity of the problem) such defect, error or nonconformity.

Software Updates

If software is supplied as part of the product, the Company will supply the registered purchaser/licensee with maintenance releases of the Company's proprietary Software Version Release in manufacture at the time of license for a period of one year from the date of license or until such time as the Company issues a new Version Release of the Software, whichever first occurs. To clarify the difference between a Software Version Release and a maintenance release, a maintenance release generally corrects minor operational deficiencies (previously non-implemented features and software errors) contained in the Software, whereas a Software Version Release adds new features and functionality. The Company shall have no obligation to supply you with any new Software Version Release of Telestream software or third party software during the warranty period, other than maintenance releases.

Restrictions and Conditions of Limited Warranty

This Limited Warranty will be void and of no force and effect if (i) Product Hardware or Software Media, or any part thereof, is damaged due to abuse, misuse, alteration, neglect, or shipping, or as a result of service or modification by a party other than the Company, or (ii) Software is modified without the written consent of the Company.

Limitations of Warranties

THE EXPRESS WARRANTIES SET FORTH IN THIS AGREEMENT ARE IN LIEU OF ALL OTHER WARRANTIES, EXPRESS OR IMPLIED, INCLUDING, WITHOUT LIMITATION, ANY WARRANTIES OF MERCHANTABILITY OR FITNESS FOR A PARTICULAR PURPOSE. No oral or written information or advice given by the Company, its distributors, dealers or agents, shall increase the scope of this Limited Warranty or create any new warranties.

Geographical Limitation of Warranty. This limited warranty is valid only within the country in which the Product is purchased/licensed.

Limitations on Remedies. YOUR EXCLUSIVE REMEDIES, AND THE ENTIRE LIABILITY OF TELESTREAM, LLC. WITH RESPECT TO THE PRODUCT, SHALL BE AS STATED IN THIS LIMITED WARRANTY. Your sole and exclusive remedy for any and all breaches of any Limited Warranty by the Company shall be the recovery of reasonable damages which, in the aggregate, shall not exceed the total amount of the combined license fee and purchase price paid by you for the Product.

Damages. TELESTREAM LLC., SHALL NOT BE LIABLE TO YOU FOR ANY DAMAGES, INCLUDING ANY LOST PROFITS, LOST SAVINGS, OR OTHER INCIDENTAL OR CONSEQUENTIAL DAMAGES ARISING OUT OF YOUR USE OR INABILITY TO USE THE PRODUCT, OR THE BREACH OF ANY EXPRESS OR IMPLIED WARRANTY, EVEN IF THE COMPANY HAS BEEN ADVISED OF THE POSSIBILITY OF THOSE DAMAGES, OR ANY REMEDY PROVIDED FAILS OF ITS ESSENTIAL PURPOSE.

Further information regarding this limited warranty may be obtained by writing:
Telestream, LLC.

848 Gold Flat Road, Suite 1
Nevada City, CA 95959

You can call Telestream via telephone at (530) 470-1300.

Contents

Preface

Copyright and Trademark Notice	i
MPEG-2 License Requirements	i
Obtaining Pipeline Support Information Assistance	i
Company and Product Information	ii
We'd Like to Hear From You!	ii
FCC Emission Information	ii
Canadian EMC Notice of Compliance	iii
Important Safety Instructions	iii
Limited Warranty and Disclaimers	iv

Chapter 1 Introduction

Pipeline Automates Real-time Media Workflows	1
Telestream's Pipeline Family of Products	2
Pipeline SC	2
Pipeline Quad	2
Pipeline HD Dual	3
Pipeline Benefits	3
A better way to capture and playout baseband media	3
Accessible from any workstation on your network	3
Edit or transcode during capture for quick turnaround	3
Cost-effective network import/export station	4
Multi-channel scalability	4
Ingest into editing workflows	4
Ingest into transcoding workflows	4

Chapter 2 Pipeline Hardware, Installation & Setup

Environmental Operating Requirements	6
Power Requirements	6

Unpack the Pipeline	6
Pipeline SC Shipping Container Contents	7
Pipeline Quad Shipping Container Contents	7
Pipeline HD Dual Shipping Container Contents	7
Locate the Pipeline SC.....	7
Locate the Pipeline Quad Pipeline HD Dual	7
Pipeline SC Hardware.....	8
Processing VBI Closed Captions and Timecode Data	8
Front Panel Indicators	8
Rear Panel Ports and Connectors	9
Pipeline Quad Hardware	10
Using SDI Sync Input	10
Using SDI Sync Out.....	11
Processing Closed Caption and Timecode Data	11
Front Panel Indicators	11
Front Panel Reset Switches	12
Rear Panel Ports and Connectors.....	13
Pipeline HD Dual Hardware	14
Using SDI Sync Input	15
Using SDI Sync Out.....	15
Processing Closed Caption and Timecode Data	15
Front Panel Indicators	16
Front Panel Reset Switches	16
Rear Panel Ports and Connectors.....	17
Connecting Pipeline to Mac OS X or Windows Computers	19
Adding Pipeline to a Network.....	20
Powering up the Pipeline	21
Configuring & Connecting to Pipelines.....	21
Configuring Pipeline Network Settings	22
Registering Your Pipeline with Telestream.....	22

Chapter 3 Installing Pipeline Software

Installing Pipeline Software	23
Upgrading Pipeline Software.....	24
Removing Pipeline Software	24

Chapter 4 Implementing Pipeline Workflows

Pipeline Application Feature Comparison	25
Workflow System Requirements	27
General Pipeline System Setup Information	27

Disk Buffering Details	36
Platform and System Requirements	37
General Pipeline Host System Requirements	37
System Requirements for FlipFactory Pipeline Workflows	37
Pipeline Host computer recommendations	38

Chapter 5 Using Pipeline Administrator

Supported Web Browsers	41
Launching Pipeline Administrator.....	42
Using Pipeline Administrator	42
Using the About Panel	43
Using the Configure Panel.....	44
Using the Quad Panel	50
Using the Counters Panel.....	53
Using the Upgrade Panel	55

Chapter 6 Using Pipeline Control

Pipeline Control Overview.....	57
Starting Pipeline Control.....	59
Creating New Pipeline Control Documents.....	59
Creating New Documents via the Task Selector.....	59
Creating New Documents via the File Menu	60
Pipeline Control Menus	61
File Menu	61
Control Menu	62
Device Menu and Keyboard Shortcuts	62
Clip Menu	63
Tools Menu	63
Help Menu	63
Using The Pipeline Settings Panel.....	64
Selecting a Pipeline	65
Selecting and Configuring Codecs	65
Selecting a Timecode Clock Source.....	67
Setting up Handles	68
Selecting a Publisher.....	68

Configuring Publishers	68
Using Vantage Publish within Pipeline Control for Windows	68
Using Agility Publish within Pipeline Control for Windows.....	71
Side Car XML Plugin	73
Copy File Publisher	74
Avid MXF Copy File Publisher	74
FlipFactory Publisher.....	75
Using the Pipeline State Panel.....	78
Using The Video Preview Panel.....	79
Deck Controls	79
Using the Audio Preview Panel.....	80
Loading and Saving Clip List Files	81
Setting Up Pipeline Control Options.....	81
Capture Tab	82
Application Tab	84
Device Tab	84
Play Out Tab	85
Update Tab	86
Discovery Tab	86
Security Tab	87
Licensing Tab.....	87
Using the Video Wall.....	88
Using the Label Editor.....	91
Using the Diagnostics Panel	92
File Formats/Wrappers.....	93
Format Wrappers.....	93
Avid AAF+MXF (OP-Atom).....	94
MXF (OP-1a)	97
Generic MXF (OP-Atom)	101
QuickTime.....	103
Telestream Intermediary Format (TIFO).....	104

Chapter 7 Using Scheduled Capture Documents

Using The Scheduled Capture Document.....	108
About Schedules	108
Creating Capture Schedules.....	109
Using the Schedule Panel.....	110

Chapter 8 Using Log & Capture Documents

Creating Clip Lists for Log and Capture	117
---	-----

Using the Log & Capture Document	118
Using Log & Capture Controls in the Preview Panel.....	119
Using the Clip List Panel	120
Performing Other Clip Tasks.....	123
Setting up and Capturing Timecode Break Recording	125

Chapter 9 Using Trigger Capture Documents

Using the Trigger Document	128
Using the Preview Panel	130
Setting up and Enabling Automatic Recording.....	130
Using CalDav Calendar.....	131
Manual & Timecode Break Recording	134
RS422	135
Viewing and Updating Metadata Labels.....	136

Chapter 10 Using Print to Tape Documents

Playout & Print to Tape Overview.....	138
Creating Print to Tape Documents	139
Using the Clip Panel.....	140

Chapter 11 Using Controlled Playout Documents

Controlled Playout Overview.....	146
Creating Controlled Playout Documents	147
Using the Clip Panel.....	149

Appendix A Troubleshooting

Gathering Information for Troubleshooting	151
Workflow Information.....	151
Pipeline Device Firmware Information.....	153
Pipeline Administrator Counters Panel Details.....	153
Obtaining Debug Logs from Pipeline Control	153

Appendix B Pipeline EDL Syntax

Pipeline EDL Syntax Requirements	155
--	-----

Appendix C Pipeline Control Codec Profiles

DNxHD Profiles	160
DV and DVCPro Profiles	160
DVCPro HD Profiles	160
IMX Profiles	161
ProRes Profiles.....	161
Motion JPEG Profiles	161
SD Uncompressed 8-bit Profiles	162
Linear PCM Profiles.....	162
Index	163

Tables

Chapter 1 Introduction

Chapter 2 Pipeline Hardware, Installation & Setup

Table 2–1. Operating and Storage Temperature Parameters.....	6
--	---

Chapter 3 Installing Pipeline Software

Chapter 4 Implementing Pipeline Workflows

Table 4–1. Feature comparison of Pipeline client applications	26
Table 4–2. Disk and Network Requirement by Media Format.....	38

Chapter 5 Using Pipeline Administrator

Table 5–1. Configure Panel controls and descriptions	45
Table 5–2. Configure Panel controls and descriptions	51
Table 5–3. Counters Panel controls and descriptions.....	53

Chapter 6 Using Pipeline Control

Table 6–1. Configuring clip file paths for Pipeline Control and FlipFactory access.l.....	78
Table 6–2. Avid AAF+MXF Format Summary	95
Table 6–3. Avid AAF+MXF Applicable Standards	95
Table 6–4. Generic MXF Format Summary.....	99
Table 6–5. MXF Applicable Standards	99
Table 6–6. MXF OP-Atom Format Summary	101
Table 6–7. MXF OP-Atom Applicable Standards	101
Table 6–8. QuickTime Open Format Summary	103
Table 6–9. QuickTime Open Applicable Standards	103
Table 6–10. TIFO Format Summary.....	105

Chapter 7 Using Scheduled Capture Documents

Table 7–1. Status badges and their descriptions.....	112
--	-----

Chapter 8 Using Log & Capture Documents

Chapter 9 Using Trigger Capture Documents

Chapter 10 Using Print to Tape Documents

Chapter 11 Using Controlled Playout Documents

Appendix A Troubleshooting

Appendix B Pipeline EDL Syntax

Appendix C Pipeline Control Codec Profiles

Table C–1. DNxHD Profiles.....	160
Table C–2. DV and DVCPro Profiles.....	160
Table C–3. DVCPro HD Profiles.....	160
Table C–4. Avid IMX Profiles.....	161
Table C–5. ProRes Profiles.....	161
Table C–6. Motion JPEG Profiles.....	161
Table C–7. SD Uncompressed Profiles.....	162
Table C–8. Linear PCM Profiles.....	162

CHAPTER 1

Introduction

Pipeline is an industry-first network-based video capture and playout device for moving SD & HD SDI video & audio in and out of Mac OS X & Windows file-based workflows. Pipeline systems provide real-time SD and HD SDI ingest and capture into industry-standard QuickTime, MXF OP1a, and MXF OPAAtom directly to any storage location.

Pipeline can also be used as the front-end capture system supplying media files that can be immediately used directly with Telestream's transcoding workflow automation tools. It can encode media into QuickTime or MXF for use in products including Apple's Final Cut Pro, Avid Media Composer, and Adobe Premiere Pro.

Pipeline captures media from tape or live sources, making it ideal for integration in broadcast, production, postproduction, government, and other professional media workflow applications. A Pipeline software development kit (SDK) is also available from Telestream, which enables integration in custom applications.

PIPELINE AUTOMATES REAL-TIME MEDIA WORKFLOWS

Designed into Pipeline is ease of use for broadcasters, post-production houses, government agencies, universities, and video professionals. Setting up a Pipeline is easy. Connect Ethernet and SDI, attach an optional VTR, and configure your network settings – you're often up and running in under ten minutes.

Figure 1–1. Pipeline automates and adds value to real-time transcoding workflows

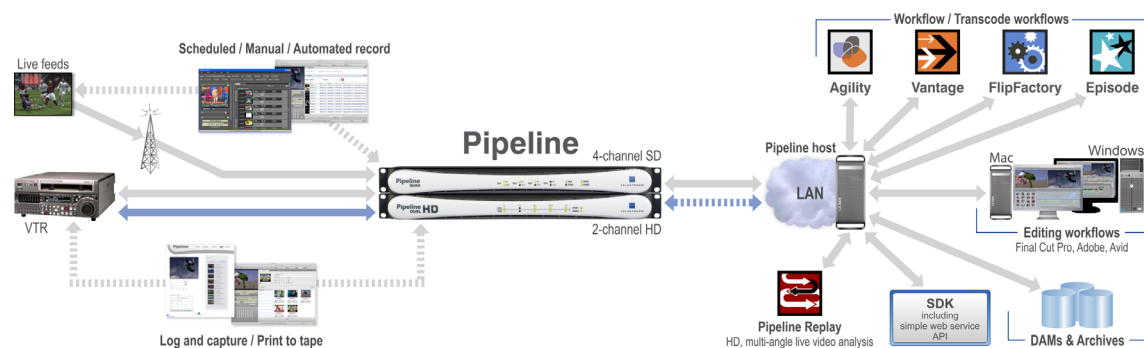

TELESTREAM'S PIPELINE FAMILY OF PRODUCTS

Pipeline SC

Pipeline SC is a single-channel, single-session device. It is ideally suited for low-volume workflows where easy location and setup is important.

Figure 1–2. Pipeline SC – compact, and easy to set up



Pipeline SC offers these features:

- Network-accessible SDI video encoding and playout
- Real-time encoding from standard definition NTSC/PAL SDI to DV, DVCPro, IMX 30|40|50, ProRes 422 SQ (SD), MJPEG A, and MPEG-2 50 mb/sec I-frame video
- Real-time decoding from SD DV, DVCPro, IMX, and ProRes 422 SQ to PAL/NTSC SDI video
- Extends FlipFactory, Final Cut Pro, and Episode to include workflows with tape or live sources
- VBI closed caption and timecode data extraction
- Shared network access to Pipeline saves time, effort and money
- Digitizes tapes into online libraries for an end-to-end DAM solution
- Records clips to tape for sharing with clients or colleagues.

Pipeline Quad

Pipeline Quad is a four-channel, rack-mounted device with Gigabit Ethernet and four independent Pipeline channels. Pipeline Quad also has a Sync Input for synchronizing output streams and for extracting VITC timecode.

Figure 1–3. Pipeline Quad – four-channels for high-volume applications



The Pipeline Quad's rack-mount form is ideal for high-volume, scalable workflows where throughput and performance are important factors.

Pipeline Quad performs all encoding and decoding available in Pipeline SC, and adds these features:

- Four concurrent, independent Pipeline channels on a single, rack-mount device
- Digital SDI sync input channel (sync in only) for frame-synchronized playout across all channels
- Optional, configurable confidence monitoring of client-bound video on a dedicated channel
- Gigabit Ethernet and dual, common power supplies for increased fail-safe operation.

Pipeline HD Dual

Pipeline HD Dual is a two-channel, rack-mounted system with dual Gigabit Ethernet enabling two independent Pipeline HD channels. Pipeline HD Dual also has an SDI Reference input for synchronizing output streams and for extracting VITC timecode.

Figure 1–4. Pipeline HD Dual – two channels for high-volume HD applications



The Pipeline HD Dual's rack-mount form is ideal for high-volume, scalable workflows where throughput and performance are important factors.

Pipeline HD Dual performs all encoding and decoding available in Pipeline SC, and adds these features:

- HD codec support for Uncompressed SD 8-bit, DVCPro50, Apple ProRes 422 HD, Avid DNxHD, and DVCProHD
- Two concurrent, independent Pipeline HD channels on a single, rack-mount device
- Digital SD or HD SDI sync input channel (sync in only) for frame synchronized playout across all channels
- Gigabit Ethernet for each channel and dual, common power supplies for increased fail-safe operation.

PIPELINE BENEFITS

A better way to capture and playout baseband media

Telestream Pipeline is a network-based video capture and playout device for moving HD and SD video and audio in and out of any file-based workflow. This cross-platform solution offers Mac OS X and Windows users more choices for fast, robust, reliable video capture.

Accessible from any workstation on your network

Pipeline provides freedom from the hassles, limitations, and expense of traditional capture-card solutions on a dedicated workstation. Common network protocols, RS-422 deck control, and frame-accurate ingest/playout make Pipeline a smart choice for any video workflow.

Pipeline provides direct support for MXF workflows, creating OPAtom and OP1a media. For users who need to maintain closed captions and other ancillary data, Pipeline offers methods of achieving this via MXF, TIFO, and Avid/Apple proprietary schemes.

In addition to capture, Pipeline provides an easy Print to Tape interface for users who need to insert edit, assemble edit, controlled playout, or crash playout back to tape.

Edit or transcode during capture for quick turnaround

Pipeline allows you to edit or transcode your media files while they are being captured. There is no need to wait for the complete file to arrive. Batch ingest from an EDL file allows you to encode multiple clips from a

single tape. Plus, real-time reliable hardware encoding removes capture card/workstation operating system and driver incompatibilities.

Cost-effective network import/export station

Pipeline enables any machine on the network to act as a dedicated, network import/export station – making it very cost effective. In addition, Pipeline offers support for direct extraction and preservation of ancillary data and a wide variety of timecode sources. A powerful Web service API makes it easy to develop applications that automate control of multiple Pipeline systems. A comprehensive SDK is available for easy integration into any workflow.

Multi-channel scalability

Pipeline Quad and Pipeline HD Dual offer unparalleled encoding power in a compact 1RU box, plus they include dual power supplies for critical workflows. Pipelines can be stacked or racked for scalability to an unlimited number of channels.

Ingest into editing workflows

Pipeline saves significant time and costs over traditional ingest solutions by importing media directly into your editing workflow. A single workstation or server can handle the demands of ingesting multiple SD or HD streams. QuickTime movie files are ready immediately, allowing incoming events and breaking news to be edited while they are being captured. External encoding allows you to use your workstation for editing instead of waiting for clips to be rendered. Additionally, Pipeline's keyboard commands allow you to set up your workflow the way you want.

Ingest into transcoding workflows

Use Pipeline for high-quality baseband ingest into your transcoding workflow. Telestream's FlipFactory, Vantage, Agility, and Episode products allow you to simultaneously create high-res files for storage while creating a low-res proxy, or create any number of additional file formats in near-realtime. Transcoding begins immediately while ingesting media, saving you time and money. Pipeline also preserves important metadata throughout your transcoding workflow.

CHAPTER 2

Pipeline Hardware, Installation & Setup

Use this chapter to unpack and set up Pipeline SC, Pipeline Quad, and Pipeline HD Dual devices, connect video equipment, and configure the Pipeline for a LAN connection. Before proceeding, work with your network administrator to determine network setting requirements: IP address, netmask, and the gateway address. You should also understand your media workflow requirements and read [Disk and Network Requirement by Media Format \(page 38\)](#).



Note

Topics in this chapter refer to all Pipeline devices unless specifically noted.

To set up and configure your Pipeline correctly, complete the tasks in this chapter, referring to [Chapter 5, Using the Configure Panel on page 44](#) for network configuration tasks.

Topics

- [Environmental Operating Requirements \(page 6\)](#)
- [Power Requirements \(page 6\)](#)
- [Unpack the Pipeline \(page 6\)](#)
- [Locate the Pipeline SC \(page 7\)](#)
- [Locate the Pipeline Quad | Pipeline HD Dual \(page 7\)](#)
- [Pipeline SC Hardware \(page 8\)](#)
- [Pipeline Quad Hardware \(page 10\)](#)
- [Pipeline HD Dual Hardware \(page 14\)](#)
- [Connecting Pipeline to Mac OS X or Windows Computers \(page 19\)](#)
- [Adding Pipeline to a Network \(page 20\)](#)
- [Powering up the Pipeline \(page 21\)](#)
- [Configuring & Connecting to Pipelines \(page 21\)](#)
- [Registering Your Pipeline with Telestream \(page 22\)](#)

ENVIRONMENTAL OPERATING REQUIREMENTS

Plan adequate space for cable routing from the back of the chassis. Ensure that the Pipeline is in close proximity to your Ethernet and video cables, and that cable connectors are not stressed, bent, or crimped. Also make sure that you have adequate space for a VTR deck, if necessary.



Caution

Do not place more than two Pipeline SCs in a stack. If you do, you risk overheating a unit, potentially leading to operational failure.

Allow at least six inches (15 cm) of space between the Pipeline and the nearest object to ensure adequate airflow. Keep the temperature range within acceptable limits (table below), and keep humidity moderate in the vicinity. Temperature specifications are as follows:

Table 2–1. Operating and Storage Temperature Parameters

Modes	Temperature Ranges
Operating Temperature	0°C to 40°C (32°F to 104°F)
Storage Temperature	-40°C to 60°C (-40°F to 140°F)

POWER REQUIREMENTS

Input Voltage. Auto-sensing 100 to 240V AC, 50/60Hz



Caution

Telestream recommends connecting computer equipment to AC power through an uninterruptible power supply (UPS) with surge protection. Fluctuations in commercial supply voltage can damage unprotected electronic equipment.

A high quality surge suppressor may be substituted if a UPS is not available, but it may not provide adequate protection.

UNPACK THE PIPELINE

Unpack the contents of the original shipping container; identify each component and determine that they are in satisfactory condition. If any shipping damage is visible, note it on your shipping documents and contact your shipping agent and Telestream or authorized Telestream distributor.



Note

Save all packaging materials and store them in a safe place. If you require service – or move your Pipeline – the packaging materials may be used for safe shipment.

Pipeline SC Shipping Container Contents

In addition to the Pipeline itself, each package contains the following:

- Software Installation and User's Guide CD-ROM
- Power adapter with power cord
- Quick Start Guide (in CD case)

Pipeline Quad Shipping Container Contents

In addition to the Pipeline itself, each package contains the following:

- Software Installation and User's Guide CD-ROM
- Power cords
- Quick Start Guide (in CD case)

Pipeline HD Dual Shipping Container Contents

In addition to the Pipeline itself, each package contains the following:

- Software Installation and User's Guide CD-ROM
- Power cords
- Quick Start Guide (in CD case)

LOCATE THE PIPELINE SC

For permanent locations, select a stable and level, smooth, hard surface. Avoid carpeted or cloth-covered surfaces which inhibit airflow or reduce heat dissipation, which contributes to overheating. Select an isolated area that provides a proper operating environment and protection from accidental damage to the Pipeline. Route power, Ethernet, and other cables to protect users from a tripping hazard and damage to the Pipeline.

LOCATE THE PIPELINE QUAD | PIPELINE HD DUAL

For permanent locations, mount the Pipeline Quad|HD Dual in a single rack-unit slot in a computer rack and secure it in place. Make sure the following issues are adequately addressed:

Elevated Operating Ambient Temperature. If installed in a closed or multi-unit rack assembly, the operating ambient temperature of the rack environment may be greater than room ambient. Therefore, consideration should be given to installing the equipment in an environment compatible with the maximum ambient temperature specified ([Operating and Storage Temperature Parameters on page 6](#)).

Reduced Air Flow. Installation of the equipment in a rack should be such that the amount of air flow required for safe operation of the equipment is not compromised.

Mechanical Loading. Mounting of the equipment in the rack should be such that a hazardous condition is not achieved due to uneven mechanical loading.

Circuit Overloading. Consideration should be given to the connecting equipment to the supply circuit and the effect that overloading of the circuits might have on over-current protection and supply wiring. Appropriate consideration of equipment nameplate ratings should be given when addressing this concern.

Reliable Earthing. Reliable earthing of rack-mounted equipment should be maintained. Particular attention should be given to supply connections other than direct connections to the branch circuit (e.g. use of power strips).

PIPELINE SC HARDWARE

The Pipeline SC is 7.5 inches (19.1 cm) wide, 5.5 inches (14.0 cm) deep, and 1.5 inches (3.8 cm) high.

Pipeline SC is a compact, network-ready SDI encoder/decoder device equipped with 10/100Mb Ethernet using TCP/IP, UDP, RTSP, and RTP. It uses Bonjour for service discovery. Additionally, it employs Serial Digital Interface (BNC, SMPTE-259M 270mb/sec) with 8-channel embedded audio input and output ports, plus automatic detection of 525/625. It also has an RS-422 deck control port using Sony 9 Pin Protocol.

Pipeline can capture and play out NTSC/PAL having DV/DVCPRO 25Mb, IMX 30|40|50 and MPEG-2 I-Frame 50Mb MJPEG, ProResSQ video (capture only) video, and 48 KHz, 16/24 bit, uncompressed audio.

Processing VBI Closed Captions and Timecode Data

Pipeline automatically processes Vertical Blanking Interval (VBI) data on ingest operations to obtain closed caption and timecode data. Closed captions are extracted from line 21, and timecode from lines 16 through 20 (5 lines beginning with line 16). The last line (usually 20) with a valid timecode is the line whose data is used. Pipeline encodes the closed caption and timecode data into the data stream of the digital output, making it available for processing by client applications, such as FlipFactory, Vantage, Agility, and Episode.

Front Panel Indicators

The front panel contains LED indicators, making it easy to check its status.

Figure 2–1. Pipeline SC front panel



There are three LEDs you use to determine the state of the Pipeline:

Power. Displays green light when power is present.

SDI In. Display green light when Pipeline is configured to encode SDI In and send it out via Ethernet. How media is encoded is determined by the selected codec. If the LED lights orange, data is being lost. The reason should be corrected before continuing operation. During a firmware upgrade, this LED lights yellow until you reboot.

SDI Out. Displays green light when the Pipeline is configured to decode digital media from the Ethernet port, and send decoded media to the SDI Out port. If the LED lights orange, data is being lost. The reason should be corrected before continuing operation.

Rear Panel Ports and Connectors

The rear panel contains the power jack, plus video and network connector ports.

Figure 2–2. Pipeline SC rear panel



When connecting video equipment, Ethernet, and RS-422 cables, be sure that the power supply is disconnected from the Pipeline. Failure to do so may result in equipment malfunction or damage.

DC Power Port. Use to connect and turn on the Pipeline. Only connect the Pipeline to power using the Telestream-supplied power supply.

10/100 Ethernet Port. The Ethernet port has two LEDs:

Link (left LED): If the LED is not lit, no link is available. If the LED is lit orange, link has been established.

Connection/Activity (right LED): If the port is connected at 100 Mb, the LED lights green, and blinks on activity. If the port is connected at 10 Mb, the LED is unlit, but blinks green during activity.

RS-422. Female DB-9 (9-pin D-connector) RS-422 port for VTR.

Pin #	Function
1	GND
2	RX-
3	TX+
4	GND
5	No Connection
6	GND
7	RX+
8	TX-
9	GND

SDI In. BNC jack for SDI input signal.

SDI Out. BNC jack for SDI output.



Caution

If the Connection LED is unlit, the Pipeline is operating at 10 Mb, which is unacceptable for real time video traffic. Resolve the problem before continuing, to avoid video stream data loss.

PIPELINE QUAD HARDWARE

The Pipeline Quad is 17.3 inches (43.9 cm) wide, 13.2 inches (33.5 cm) deep, and 1.5 inches (3.8 cm) high. Pipeline Quad is a single rack unit device, with four onboard SDI encoder/decoder devices equipped with an external Gigabit Ethernet port and an onboard switch routing 100Mb Ethernet to each device, using TCP/IP, UDP, RTSP, and RTP and Bonjour for service discovery. Serial Digital Interfaces are provided for each device (BNC, SMPTE-259M 270mb/sec).

There are 4 SDI in and out ports (per Quad, not per channel), each supporting up to 16 channels of embedded audio, with four SDI in and out ports (per Quad) with automatic detection of 525/625, and RS-422 deck control ports, using Sony 9 Pin Protocol.

Pipeline Quads can encode and decode NTSC or PAL with DV/DVCPRO 25Mb, IMX 30, 40, 50, MPEG2 I-Frame 50Mb MJPEG, and ProRes SQ video (encode only, in FlipFactory workflows), and 48 kHz, 16 and 24 bit, uncompressed audio, in up to four concurrent sessions; each individual Pipeline channel operates independently, each communicating via a common physical Ethernet port on the Quad's backplane.

The Pipeline Quad and HD Dual provides common, dual power supplies for redundancy and fail-safe operation. Telestream highly recommends that both power supplies be connected during operations. The Pipeline can operate normally on a single power supply, however you will lose the redundant safety of the second power supply.

Using SDI Sync Input

The SDI Sync Input is used in both capture and playout modes, but for two different purposes.

In capture mode, the SDI Sync Input is used as a method for supplying a common timecode reference to all input channels. For the timecode to be extracted, the SDI signal connected to the SDI Sync Input must contain a valid timecode in the ancillary data area of the signal. The SDI signal must be a digital signal that is frame synchronized with the SDI signals used as input video sources connected to each channel's input. An analog sync/reference signal, such as bi-level or tri-level, cannot be connected to the SDI Sync input.

In playout mode, the SDI Sync Input is used as a frame synchronization source for each channel's SDI outputs. Any timecode on the SDI Sync Input is ignored in this mode. If no signal is connected to the SDI Sync Input, each channel's SDI output will be frame synchronized to the video input. If no video input is connected, each channel's SDI output will free run. This means they will not be synchronized with each other or with any common reference. An analog sync/reference signal, such as bi-level or tri-level, cannot be connected to the SDI Sync input.



Note

The Sync Input signal must match the intended video output signal's frame size, frame rate and line scan (interlaced or progressive) modes.

Using SDI Sync Out

Re-clocked loop-through port of SDI Sync In. You can use this re-clocked reference for additional Pipelines or other devices. This output is only active when the Pipeline device is powered up and is in an operational state.

Processing Closed Caption and Timecode Data

Pipeline automatically processes Ancillary Data on ingest operations to obtain closed captions and timecode data. Pipeline encodes the closed caption and timecode data into the data stream of the digital output, making it available for further processing by client applications, such as FlipFactory, Vantage, Agility, and Episode.

The Pipeline automatically analyzes the signal during the Vertical Blanking Interval (VBI) on ingest operations to obtain closed captions and timecode data. Closed caption data is extracted from line 21, and timecode data from lines 16 through 20 (the 5 lines beginning with line 16). The last line (usually line 20) with a valid timecode is the line whose data is used.

Front Panel Indicators

The front panel contains LED indicators, making it easy to check its status.

Figure 2–3. Pipeline Quad front panel

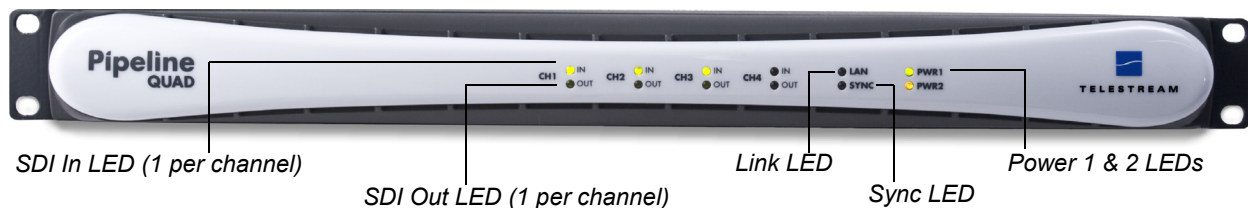

SDI In. One per channel. Lights green when the Pipeline is configured to encode SDI In and send it out via the Ethernet port. Media is encoded based on the selected codec. If the LED lights orange, data is being lost. Correct problem before continuing. During a firmware upgrade, the LED lights yellow until the upgrade completes and the Pipeline is automatically rebooted.

SDI Out. One per channel. Lights green when the Pipeline is configured to decode digital media from the Ethernet port, and send decoded media to the SDI Out port. If the LED lights orange, data is being lost. The problem should be corrected before continuing operation.

The LED blinks orange at one second intervals when the internal Ethernet switch and network that connects the four Pipelines has failed. Usually, at least one of the Pipelines can't communicate, indicating that potentially an input channel has failed, and confidence monitoring is not operational. Reboot Pipeline to solve the problem, or contact Telestream customer service.

Link. Lights green when Ethernet link has been established.

Sync. Lights green when an SDI signal is detected on the sync reference input channel.

PWR 1 & 2. Lights green when power is present and the power supply is operating normally. PWR1 indicates power supply 1; PWR2 indicates power supply 2. An orange PWR LED indicates a failed power supply or that no power is present.

If a power supply fails, complete jobs in progress. RMA the Pipeline to Telestream for repair as soon as practical.

Front Panel Reset Switches

With the front panel bezel removed, five recessed reset buttons are exposed. They are not labeled.

Figure 2–4. Pipeline Quad reset switches behind front panel

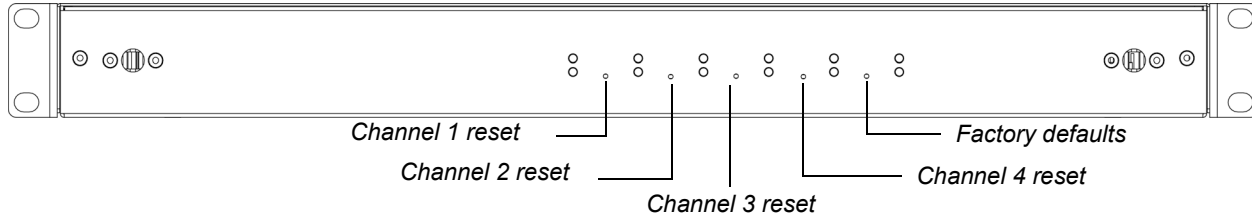

Channel 1 Reset. Insert a pointed object to depress the recessed button to perform a hardware reset on Channel 1. The channel will be disconnected from any client currently attached.

Channel 2 Reset. Insert a pointed object to depress the recessed button to perform a hardware reset on Channel 2. The channel will be disconnected from any client currently attached.

Channel 3 Reset. Insert a pointed object to depress the recessed button to perform a hardware reset on Channel 3. The channel will be disconnected from any client currently attached.

Channel 4 Reset. Insert a pointed object to depress the recessed button to perform a hardware reset on Channel 4. The channel will be disconnected from any client currently attached.

Factory Default Reset. Insert a pointed object to depress the recessed button to restore the factory defaults of the Pipeline device. Both channels are returned to their original factory default values, including IP address and global options selected. During reset all LEDs glow green. When reset is complete, the LEDs return to their normal state.



Note

Resetting factory defaults does not change the firmware or app loader versions.

Rear Panel Ports and Connectors

The rear panel contains power plugs, plus video and network connector ports.

Figure 2–5. Pipeline Quad rear panel

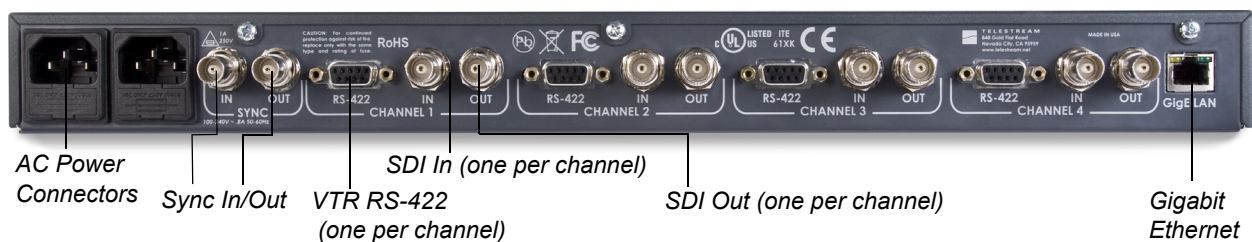

When connecting video equipment, Ethernet, and RS-422 cables, be sure that the power supply is disconnected from the Pipeline. Failure to do so may result in equipment malfunction or damage.

AC Power Plugs. Use to connect and turn on the Pipeline. Only connect the Pipeline Quad to power using the Telestream-supplied power cords. To insure fail-safe operation, be sure to use both power supplies. These supply common power to the Pipeline; if one power supply fails, the Pipeline continues to operate.

Sync In. The SDI Sync Input is used in both capture and playout modes, but for two different purposes.

In capture mode, the SDI Sync Input is used as a method for supplying a common timecode reference to all input channels. For the timecode to be extracted, the SDI signal connected to the SDI Sync Input must contain a valid timecode in the ancillary data area of the signal. The SDI signal must be a digital signal that is frame-synchronized with any SDI signals used as video sources connected to each channel's input. An analog signal cannot be connected to the SDI Sync input.

In playout mode, the SDI Sync Input is used as a frame-synchronization source for each channel's SDI outputs. Any timecode on the SDI Sync Input is ignored in this mode. If no signal is connected to the SDI Sync Input, each channel's SDI output will free run (they will not be synchronized with each other or with any common reference).



Note

Pipeline does not support any analog (bi-level or tri-level) reference. Do not attempt to use any form of analog reference with Pipeline.

Sync Out. Re-clocked loop-through port of SDI Sync In. You can use this re-clocked reference for additional Pipelines or other devices.

RS-422. Female DB-9 (9-pin D-connector) RS-422 port for VTR (one per channel).

Pin #	Function
1	GND
2	RX-
3	TX+
4	GND
5	No Connection
6	GND
7	RX+
8	TX-
9	GND

SDI In. BNC jack for SDI input (one per channel).

SDI Out. BNC jack for SDI output (one per channel).



WARNING

SDI-OUT is intended to be used for monitoring of the looped SDI-IN input source and should *not* be used to distribute this source to additional capture channels. Do not connect the looped SDI-OUT signal into any other Pipeline SDI-IN port. This may cause unintended capture interruptions on the channel connected to the looped source.

Gigabit Ethernet Port. The Ethernet RJ-45 jack has two LEDs: If the left, orange LED is lit and the right, green LED is lit, the port is operating at 1Gbs (gigabit). If only the orange LED is lit, the Ethernet port is not

connected. Be sure to use CAT-6 cabling end-to-end from Pipeline to your Macintosh or Windows PC client for best results.



Caution

If only the green LED is lit or the LED is unlit, the Pipeline is operating at 100 or 10 Mb respectively. These data rates are unacceptable for real time video traffic from all four channels. Resolve the problem by connecting at 1 Gbs before processing jobs to avoid data loss.

PIPELINE HD DUAL HARDWARE

The Pipeline HD Dual is 17.3 inches (43.9 cm) wide, 13.2 inches (33.5 cm) deep, and 1.5 inches (3.8 cm) high. Pipeline HD Dual is a single rack unit device with two onboard HD/SD-SDI encoder/decoder devices equipped with two external Gigabit Ethernet ports. It uses TCP/IP, UDP, RTSP, and RTP and Bonjour for service discovery. Serial Digital Interfaces are provided for each device (BNC, SMPTE-259M 270mb/sec) with 2 SDI in and out ports (per HD Dual), each supporting up to 16 channels of embedded audio, with automatic input format detection. It also provides RS-422 deck control ports using Sony 9-Pin Protocol.

Pipeline HD Dual can encode DV/DVCPRO 25/50, IMX 30|40|50, MPEG-2 50M I-frame (FlipFactory workflows) MJPEG, ProRes HQ/SQ/LT/Proxy, Avid DNxHD and DVCProHD video, and 48 KHz, 16/24 bit, uncompressed audio.

The Pipeline Quad and HD Dual provides dual power supplies for redundancy and fail-safe operation. Telestream highly recommends that both power supplies be connected during operations. Pipeline can operate normally on a single power supply, however you will lose the redundant safety of the second power supply.

Using SDI Sync Input

The SDI Sync Input is used in both capture and playout modes, but for two different purposes.

In capture mode, the SDI Sync Input is used as a method for supplying a common timecode reference to all input channels. For the timecode to be extracted, the SDI signal connected to the SDI Sync Input must contain a valid timecode in the ancillary data area of the signal. The SDI signal must be a digital signal that is frame synchronized with the SDI signals used as input video sources connected to each channel's input. An analog sync/reference signal, such as bi-level or tri-level, cannot be connected to the SDI Sync input.

In playout mode, the SDI Sync Input is used as a frame synchronization source for each channel's SDI outputs. Any timecode on the SDI Sync Input is ignored in this mode. If no signal is connected to the SDI Sync Input, each channel's SDI output will be frame synchronized to the video input. If no video input is connected, each channel's SDI output will free run. This means they will not be synchronized with each other or with any common reference. An analog sync/reference signal, such as bi-level or tri-level, cannot be connected to the SDI Sync input.



Note

The Sync Input signal must match the intended video output signal's frame size, frame rate and line scan (interlaced or progressive) modes.

Using SDI Sync Out

Re-clocked loop-through port of SDI Sync In. You can use this re-clocked reference for additional Pipelines or other devices. This output is only active when the Pipeline device is powered up and is in an operational state.

Processing Closed Caption and Timecode Data

Pipeline automatically processes Ancillary Data on ingest operations to obtain closed captions and timecode data. Pipeline encodes the closed caption and timecode data into the data stream of the digital output, making it available for further processing by client applications, such as FlipFactory and Episode.

When a Standard Definition SDI signal is connected, the Pipeline automatically analyzes the signal during the Vertical Blanking Interval (VBI) on ingest operations to obtain closed captions and timecode data. Closed caption data is extracted from line 21, and timecode data from lines 16 through 20 (the 5 lines beginning with line 16). The last line (usually line 20) with a valid timecode is the line whose data is used.

When an HD SDI signal is connected, the Pipeline automatically processes all ancillary data packets to obtain closed captions and timecode data. Closed caption data is extracted from Ancillary data packets with a DID of 0x161 and timecode data is extracted from Ancillary data packets with a DID of 0x260.

Front Panel Indicators

The front panel contains LED indicators, making it easy to check its status.

Figure 2–6. Pipeline HD Dual front panel

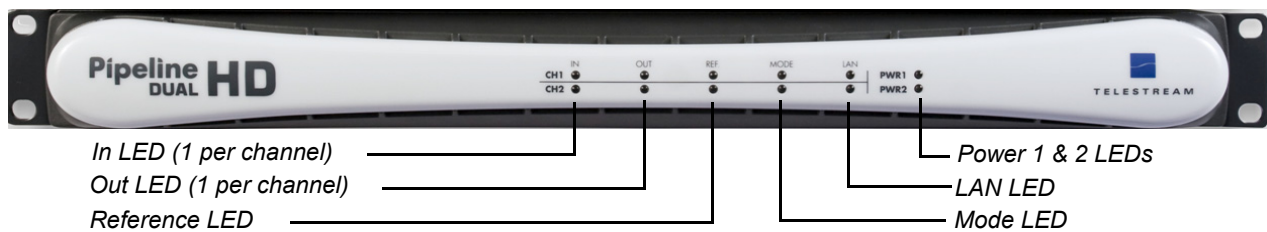

SDI In. One per channel. Lights green continuously when an HD source is connected. Flashes green when an SD source is connected. If the LED flashes orange, data is being lost. The problem should be corrected before continuing operation.

SDI Out. One per channel. Lights green continuously when HD format media is being output. Flashes green when SD format media is being output. If the LED lights orange, data is being lost. The problem should be corrected before continuing operation.

Mode. Lights green continuously when the selected codec is creating HD content. Flashes green when the selected codec is creating SD content.

Reference. Lights green continuously when an HD source signal is detected on the sync input reference channel. Flashes green when the source signal is SD.

Sync. Lights green when an HD source signal is detected on the sync input reference channel. Flashes green when the source signal is SD.

LAN. Flashes green to indicate LAN activity.

PWR 1 & 2. Lights green when power is present and the power supply is operating normally. PWR1 indicates power supply 1; PWR2 indicates power supply 2. Orange indicates a failed power supply or that

power is not present. If a power supply fails, complete jobs in progress and RMA the Pipeline to Telestream for repair as soon as practical.

Front Panel Reset Switches

With the front panel bezel removed, three recessed reset buttons are exposed. They are not labeled.

Figure 2–7. Pipeline HD Dual reset switches behind front panel

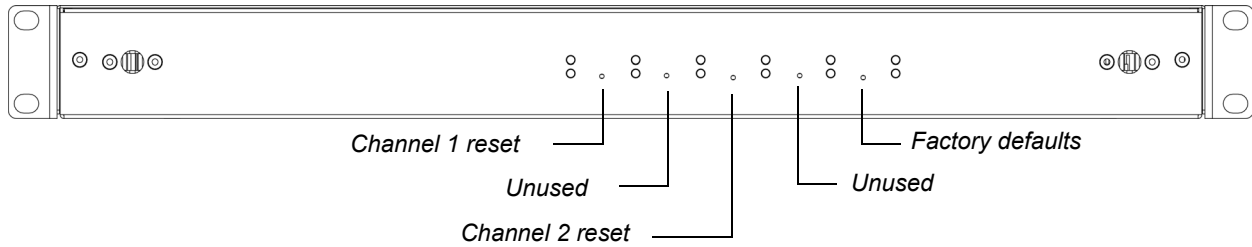

Channel 1 Reset. Insert a pointed object to depress the recessed button to perform a hardware reset on Channel 1. The channel will be disconnected from any client currently attached.

Channel 2 Reset. Insert a pointed object to depress the recessed button to perform a hardware reset on Channel 2. The channel will be disconnected from any client currently attached.

Factory Default Reset. Insert a pointed object to depress the recessed button to restore the factory defaults of the Pipeline device. Both channels are returned to their original factory default values, including IP address and global options selected. During reset all LEDs glow green. When reset is complete, the LEDs return to their normal state.



Note

Resetting factory defaults does not change the firmware or app loader versions.

Rear Panel Ports and Connectors

The rear panel contains power plugs, plus video and network connector ports.

Figure 2–8. Pipeline HD Dual rear panel

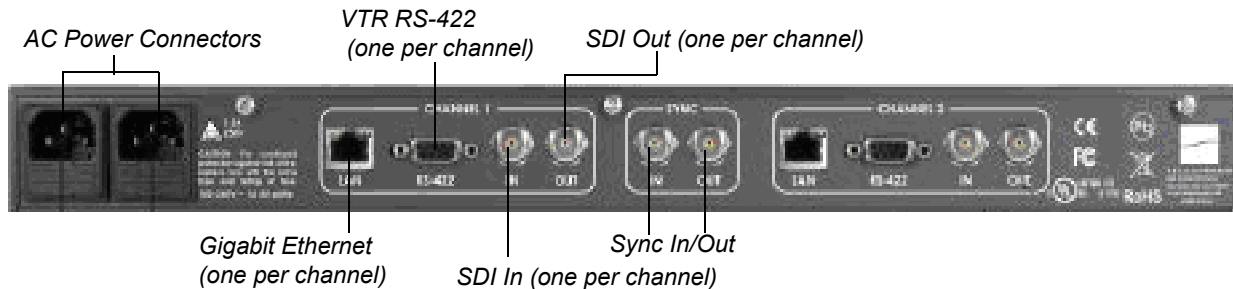

When connecting video equipment, Ethernet, and RS-422 cables, be sure that the power supply is disconnected from the Pipeline. Failure to do so may result in equipment malfunction or damage.

AC Power Plugs. Use to connect and turn on the Pipeline. Only connect the Pipeline Quad to power using the Telestream-supplied power cords. To insure fail-safe operation, be sure to use both power supplies. These supply common power to the Pipeline; if one power supply fails, the Pipeline continues to operate.

Sync In. The SDI Sync Input is used in both capture and playout modes, but for two different purposes.

In capture mode, the SDI Sync Input is used as a method for supplying a common timecode reference to all input channels. For the timecode to be extracted, the SDI signal connected to the SDI Sync Input must contain a valid timecode in the ancillary data area of the signal. The SDI signal must be a digital signal that is frame-synchronized with any SDI signals used as video sources connected to each channel's input. An analog signal cannot be connected to the SDI Sync input.

In playout mode, the SDI Sync Input is used as a frame-synchronization source for each channel's SDI outputs. Any timecode on the SDI Sync Input is ignored in this mode. If no signal is connected to the SDI Sync Input, each channel's SDI output will free run (they will not be synchronized with each other or with any common reference).



Note

Pipeline does not support any analog (bi-level or tri-level) reference. Do not attempt to use any form of analog reference with Pipeline.

Sync Out. Re-clocked loop-through port of SDI Sync In. Use for additional Pipelines or other devices.

RS-422. Female DB-9 (9-pin D-connector) RS-422 port for VTR (one per channel).

Pin #	Function
1	GND
2	RX-
3	TX+
4	GND
5	No Connection
6	GND
7	RX+
8	TX-
9	GND

SDI In. BNC jack for SD-SDI or HD-SDI input (one per channel).

SDI Out. BNC jack for SD-SDI or HD-SDI output (one per channel).



WARNING

SDI-OUT is intended to be used for monitoring of the looped SDI-IN input source and should *not* be used to distribute this source to additional capture channels. Do not connect the looped SDI-OUT signal into any other Pipeline SDI-IN port. This may cause unintended capture interruptions on the channel connected to the looped source.

Gigabit Ethernet Ports. Each Ethernet RJ-45 jack has two LEDs: If the left, orange LED is lit and the right, green LED is lit, the port is operating at 1Gbs (gigabit). If only the orange LED is lit, the Ethernet port is not connected. Be sure to use CAT-6 cabling end-to-end from Pipeline to your Macintosh or Windows PC client for best results.



Caution

If only the green LED is lit or the LED is unlit, the Pipeline is operating at 100MB or less – rates unacceptable for real time video on all four channels. Resolve the problem by connecting at 1 Gb/sec. before processing jobs to avoid data loss.

CONNECTING PIPELINE TO MAC OS X OR WINDOWS COMPUTERS

Pipeline can be connected to a Mac OS X computer – a Final Cut Pro workstation or Episode Engine server, for example. Or, it can be connected to a Windows computer – a FlipFactory server or Pipeline Control workstation, for example. You can connect Pipelines directly or via LAN using a Gigabit Ethernet (Gig-E) switch for Pipeline Quad|HD Dual or 100MB Ethernet for Pipeline SC.



Note

For workstations or servers with multiple network adapters, you should always connect the Pipeline (or switch) to the second interface on the system (Windows: Local Area Connection 2, Mac OS X: en1).

If you are not able to connect to Pipelines using this configuration you may have devices on your first network using the same address scheme as your Pipelines. To correct this, run the following commands in a command window (verify with your network administrator).

This example is for modifying your system's routing table for a Pipeline configuration using the default 169.254.xxx.xxx self-assigned address scheme. Modify these commands accordingly for your configuration:

Mac OS X:

To remove:

```
sudo route delete -net 169.254.0.0/16
```

To add it back to en1:

```
sudo route add -net 169.254.0.0/16 -interface en1
```

Windows:

When Pipeline Control discovers Pipelines on the network, it records the Network Interface Card (NIC) that the Pipeline responded on. The computer's routing tables are then examined to see if a valid route is available to the Pipeline Control application on which to communicate. If a valid route is not found then Update Route is displayed. Click Update Route to add a valid entry into the computer's routing table.

Click R

R	Status	Name	IP Address	Source	Version	Type	NIC
	Idle	Engineering>David>HD 1	169.254.12.1	1080@29.97	2.5.66142.0	HD	Local Area Connection 3
	Idle	Engineering>David>HD 2	169.254.12.2	1080@29.97	2.4.55118.0	HD	Local Area Connection 3
	Idle	Engineering>David>SD 1	169.254.12.194	NTSC	2.2.53225.0	SD	Local Area Connection 3
	Idle	Engineering>David>SD 2	169.254.12.204	NTSC	2.2.53225.0	SD	Local Area Connection 3
	Idle	Pipeline_3050x	169.254.12.235	PAL	2.5.66107.0	SD	Local Area Connection 3
	Idle	PipelineQuad_400_1	192.168.100.1	NTSC	2.5.66107.0	SD	Local Area Connection 3
	Idle	PipelineQuad_400_3	192.168.100.3	NTSC	2.4.60248.0	SD	Local Area Connection 3
	Idle	PipelineQuad_400_4	169.254.10.3	NTSC	2.5.64549.0	SD	Local Area Connection 3

Click Update Route

Click R to refresh status. A green bullet icon indicates that this Pipeline is available. A red bullet indicates that it is currently busy (connected to another client application). Gray indicates offline; yellow indicates an unknown state. To enable you to select a Pipeline to set up a document for use later, you can select a Pipeline regardless of its state. This dialog reports the Pipeline's current status (idle, capturing, recording, unknown), name, input source, firmware version, device type (SD or HD) and system NIC connection.

If any type of Bonjour is installed, the R icon is greyed out and the refresh functionality is not available.

Use the instructions in this section to make Ethernet and video connections to your Pipeline when connecting it to a Mac OS X or Windows computer – either directly or via a switch.

Figure 2–9. Pipeline video, VTR & network connections

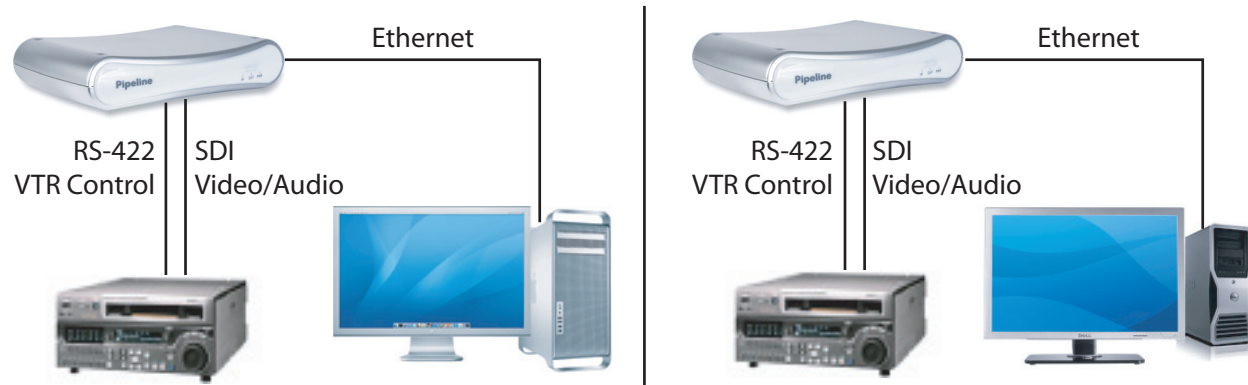

1. Make sure the Pipeline is not plugged in.
2. Connect the Pipeline Ethernet port directly, or via a switch, to the computer with an Ethernet cable. (A crossover cable may be required for direct connections with some NICs.)
3. Connect your VTR SDI Out port to the Pipeline SDI In port with a BNC coax cable connected to your video source – a VTR, for example.
4. (Optional) Connect the VTR RS-422 port to the Pipeline RS-422 port.
5. (Pipeline Quad/HD – Optional) Connect video equipment to your Sync In and Sync Out video ports.

ADDING PIPELINE TO A NETWORK

One or more Pipelines can connect to a LAN. To assure acceptable performance, be sure to connect Pipelines to a media network or a *single* Gigabit switch dedicated specifically for Pipelines, edit stations, and media servers. If you connect to a backbone, ensure it is Gigabit, to handle the real-time traffic. Make certain that switches do not have a firewall, and that TCP and UDP ports 7000/7002 (video), 7004/7006 (audio), 7008/7010 (status), 554 (RTSP), and 80 (http) are open.

Each Pipeline channel is assigned a unique, automatically assigned, link-local IP address in the range 169.254.1.0 to 169.254.255.255, so that it can communicate directly with your computer without a gateway. Each of the Pipelines (*channels*) in a Pipeline HD Dual and Pipeline Quad is assigned an incremental IP address.

You can also set up the Pipeline with a static address. Make IP address modifications with Pipeline Administrator, a Web application built into each Pipeline ([Using the Configure Panel on page 44](#)).



WARNING

Do not enable Windows or Internet Explorer Proxy server on a Pipeline System host machine. This may cause various network and performance issues related to the Pipeline Control application.

Use these instructions to make power, Ethernet, and video connections to one or more Pipelines when connecting it to a LAN where FlipFactory server or Final Cut Pro editing stations are located.

Figure 2–10. Pipeline video, VTR control & network LAN connections

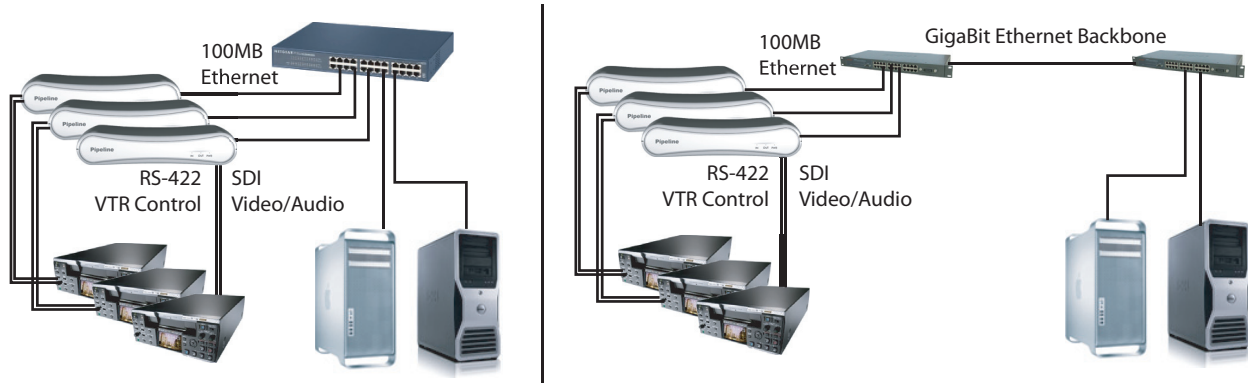

1. Make sure the Pipeline is not plugged in.
2. Connect the Pipeline Ethernet port to a network switch with an Ethernet cable on the same LAN as your Final Cut Pro editing station or FlipFactory server.
3. Connect each Pipeline SDI IN port to an SDI source such as your VTR or SDI router with a BNC cable.
4. (Optional) Connect each Pipeline's RS-422 port to an RS-422 control, such as your VTR.
5. (Pipeline Quad and HD Dual – Optional) Connect video equipment to your Sync In and Sync Out video ports.



Note

Do not enable Windows or Internet Explorer Proxy server on a Pipeline System host machine. This may cause various network and performance issues related to the Pipeline Control application.

POWERING UP THE PIPELINE

For Pipeline SC, plug the Telestream-supplied power adapter jack into the power port on the rear panel, and then connect the power cord to an AC source (or power converter) to power the Pipeline on.

For Pipeline HD Dual and Pipeline Quad (with redundant power supplies) plug both Telestream-supplied power cords into the power plugs on the rear panel, and then connect each power cord to an AC source (or power converter) to power the Pipeline on.

CONFIGURING & CONNECTING TO PIPELINES

As with other network devices, each Pipeline has a fixed MAC address and a default IP address, which you can change. Before using Pipeline, you'll need to contact your IT administrator (especially when connecting to a LAN) to determine which IP address and net mask to use for each Pipeline and how to set it up (automatic link-local, DHCP F/W v2.4 or earlier, or static), based on your facility's network address policy.

Configuring Pipeline Network Settings

To view and modify the Pipeline's network configuration, log on and display the Configure panel (click Configure in the toolbar at the top of Pipeline Administrator). See [Using the Configure Panel on page 44](#).

After plugging the Pipeline into the network and powering it on, you can connect to Pipeline via Bonjour, or you can use the Pipeline's default IP address.

When you connect, Pipeline Administrator displays in your browser. For details on using Pipeline Administrator, see [Chapter 5, Using Pipeline Administrator on page 41](#).



Note

In the unlikely event that you can't connect, try these steps:

Make sure the Pipeline is connected to a switch on your LAN and powered on, and the Power LED on the front is lit.

Ping the Pipeline using the IP address. If you can't ping it, there may be an IP address conflict, causing Pipeline to use a secondary address. Unplug the Pipeline and connect the Pipeline directly to a computer via an Ethernet cable, plug it in and ping it again.

If you're connected directly to a computer, but can't ping it, you may be using a standard Ethernet cable, but due to computer limitations, you need to use a cross-over cable.

If you can ping the Pipeline but still can't connect, you may have a firewall blocking the connection.

See Appendix A, TroubleShooting, for assistance.

REGISTERING YOUR PIPELINE WITH TELESTREAM

When the Pipeline is operational and you can connect via Pipeline Administrator, register the Pipeline with Telestream – display the About panel and click the Register button. Follow the steps on the Web page to complete registration.

If the computer you're using is on a LAN without Internet access, use a computer that has Internet access and go to dynamic.telestream.net/pipeline-register/register.asp to register your Pipeline. You should register your Pipeline to ensure ongoing warranty service and customer service, per the terms of service.

CHAPTER 3

Installing Pipeline Software

Use this chapter to install, upgrade, or uninstall Pipeline software.

Topics

- [Installing Pipeline Software \(page 23\)](#)
- [Upgrading Pipeline Software \(page 24\)](#)
- [Removing Pipeline Software \(page 24\)](#)



Notes

Telestream recommends that Pipeline Control be installed on a computer that is not hosting FlipFactory, Vantage, Agility, Episode Engine, or other media processing applications: intense disk and CPU consumption can interfere with proper operation of both applications.

Be sure to review your platform, system and workflow requirements before installing Pipeline software ([Chapter 4, Implementing Pipeline Workflows on page 25](#)). When you install or upgrade Pipeline client software, you may have to upgrade the firmware revision in your Pipeline hardware.

Pipeline Control software captures data coming from one or more Pipeline channels, and write this data to disk in real-time. To prevent interference with the Pipeline Control, any process (such as real-time anti-virus scanning) should be disabled while Pipeline Control is in use. Other processes that periodically run (such as operating updates) should also be disabled.

INSTALLING PIPELINE SOFTWARE

Pipeline Control for Windows is distributed from Telestream's Web site (www.telestream.net) as an EXE file, and is also distributed on the Pipeline CD. After verifying that you have all of the required subsystems (below), download or open the installer and run it. Follow the steps to install Pipeline Control for Windows.



Note

Pipeline Control requires local Admin privileges for installation.

UPGRADING PIPELINE SOFTWARE

Pipeline software upgrades are periodically posted on the Telestream Web site at www.telestream.net. On the Telestream site, click Support > Support Home, then select Pipeline under the Pipeline section – Pipeline software updates are displayed in the left column.

Before running the installer, be sure to remove the previous version of Pipeline, using Add/Remove Programs in Control Panels. Then, follow the instructions in Installing Pipeline Software (above) to upgrade your Pipeline software.

REMOVING PIPELINE SOFTWARE

To uninstall Pipeline Control, display Control Panel > Add/Remove programs (Programs and Features in Windows 7). Select Pipeline Control and click Remove. Removing the Pipeline application does not remove any schedules you've made, or any media you've saved on the computer from which you are removing Pipeline Control.

CHAPTER 4

Implementing Pipeline Workflows

To implement Pipeline workflows, which capture or play out media on Mac OS X or Windows, you'll need to install Pipeline software. Use this chapter to determine your workflow and system requirements, and to install, update, or uninstall Pipeline software.



Note

Telestream recommends that you only install Pipeline Control on a computer that is not hosting FlipFactory, Vantage, Agility, Episode Engine, or other media processing applications: intense disk and CPU consumption can interfere with proper operation of both applications.

When you install or update Pipeline client software, you may have to upgrade the firmware revision in your Pipeline hardware.

Topics

- [Pipeline Application Feature Comparison \(page 25\)](#)
- [Workflow System Requirements \(page 27\)](#)
- [General Pipeline System Setup Information \(page 27\)](#)
- [Disk Buffering Details \(page 36\)](#)
- [Disk and Network Requirement by Media Format \(page 38\)](#)



Note

If you haven't installed the Pipeline yet, proceed to [Chapter 2, Pipeline Hardware, Installation & Setup on page 5](#) before continuing.

Before you use a Pipeline to capture and play out media, the device must be configured using Pipeline Administrator ([Chapter 5, Using Pipeline Administrator on page 42](#)).

PIPELINE APPLICATION FEATURE COMPARISON

Pipeline software includes two applications – Pipeline Control and Pipeline Plugin for Episode and Final Cut Pro, compared below.

Pipeline Control. Pipeline Control is available for Mac OS X Snow Leopard, Windows 2008 Server, and Windows 7. You can use Pipeline Control to capture or play out media from/to Pipeline SC, Pipeline Quad, and Pipeline HD Dual.

Pipeline Plugin for Final Cut Pro and Episode | Episode Pro. The feature set of Telestream's Pipeline applications vary by platform, and by program type - application or plugin. The following table identifies the features implemented in each Pipeline program:

Table 4–1. Feature comparison of Pipeline client applications

Pipeline Software Features	Pipeline Control (Windows)	Pipeline Control (Mac OS X)	Pipeline Log & Capture Plugin
Supports Pipeline HD Dual	✓	✓	✓
Supports Pipeline SC and Pipeline Quad	✓	✓	✓
24-hour recurring record	✓	✓	
24-hour recurring playout		✓	
Log & Capture with deck control	✓	✓	✓
Triggered manual and automated capture	✓	✓	
Print to Tape – Insert Edit	✓	✓	✓
Print to Tape – Assemble Edit	✓	✓	✓
Print to Tape – Crash Playout	✓	✓	✓
Web Service API	✓	✓	
Open directly from Final Cut Pro			✓
Open directly from Episode Desktop			✓
Edit while capturing	✓	✓	
Transcode while capturing (FlipFactory Episode Engine)	✓	✓	
Import Pipeline G4G EDL files	✓	✓	✓
Import Export Final Cut Interchange files	✓	✓	✓
Create QuickTime Open files directly	✓	✓	
Create QuickTime Closed files directly	✓	✓	✓
Create TIFO files directly	✓	✓	
Controlled Playout (Virtual VTR)	✓		
Video Wall	✓		
Create Avid AAF/MXF OPAtom files directly	✓	✓	
Create Generic MXF DNxHDOP1a files with with DV DVCPro IMX video essence	✓	✓	

Pipeline Log and Capture Plugin

You can install the Pipeline Plugin in Final Cut Pro Version 5.01 or later, and you can install it in Episode v5.x (this plug-in is not compatible with Episode v6).

When you install the plugin, you can use all of the Pipeline features listed in the table above. For complete details, [Using Pipeline in Final Cut Pro & Episode on page 63](#).

WORKFLOW SYSTEM REQUIREMENTS

Pipeline applications can be used with these versions of FlipFactory, Vantage, Episode, and Final Cut Pro:

- FlipFactory 6.0 with Service Pack 5, FlipFactory 6.1, 7.0 and 7.1.
- Episode Engine version 5.0 or greater
- Final Cut Pro Version 5.1.4 or newer
- Vantage 1.0 or later

GENERAL PIPELINE SYSTEM SETUP INFORMATION

Pipeline is a unique, network-attached encoder that can be used in a variety of capture and playout workflows. As a network device, architectural constraints figure prominently in configuring an efficient and reliable Pipeline workflow.

Pipeline System Architecture

Pipeline capture workflows consist of ingesting baseband HD/SD-SDI input, compressing it, creating a file with the compressed data, and delivering the completed file to a folder location. You can connect one or more Pipelines (Single, Quad, or HD Dual) to a Pipeline host computer (Mac OS X or Windows).

Pipelines should be connected directly via CAT6 Ethernet to a Pipeline host computer or via an enterprise class, fully non-blocking, professional-quality Ethernet switch.

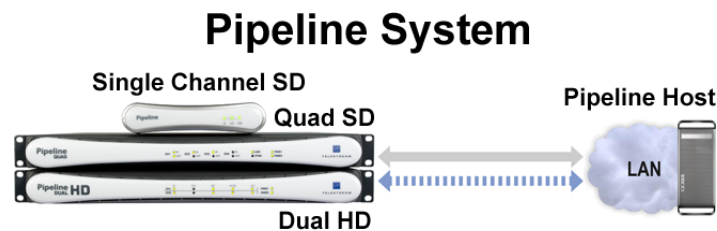

The key components include the Pipeline device itself, the network, the Pipeline host computer, the Pipeline Control application, software and the Pipeline media disk storage device. Each of these components is described below.

The Pipeline Device

Each Pipeline has one to four channels each (single channel, Quad or HD Dual) with SDI I/O for capture and play out. The SDI connectors ingest baseband SD/HD-SDI signals, compress them into one of many supported formats and stream the compressed data out their respective Ethernet ports using Real Time Streaming Protocol (RTSP). Each channel's RTSP stream contains video, audio and application/control data in RTP transport packets. These streams are ingested by the Pipeline Control application running on a Pipeline host computer.

Pipeline Host & Pipeline Application Software

The Pipeline Control wraps each RTSP stream into the appropriate file wrapper and delivers these files to their respective media storage locations. The Pipeline host computer is primarily responsible for delivering one or more Pipeline channel's RTSP streams via Ethernet to the Pipeline application it is hosting.

A Pipeline host computer can control multiple Pipeline channels concurrently. See the examples below to determine how best to configure a Pipeline System to meet your particular needs.

Pipeline applications, such as Pipeline Control, perform many tasks. These tasks include scheduled capture and play out, log/capture from tape sources, manual and automated capture from live sources, print to tape, and controlled playout.

Pipeline applications also provide interfaces to (or within) video edit software, FlipFactory, Vantage, Agility, Episode Engine, Episode desktop, and disk file systems.

There are five key factors to consider when configuring your Pipeline host system:

- CPU cores and speed
- Disk storage systems (both for the media destination and for disk buffering)
- Network connection
- System RAM
- System Video Card

Use the system descriptions, recommended systems chart, and network and storage sections to configure your Pipeline host system appropriately for your workflow requirements.

Pipeline Network

For best results, Pipelines should be connected directly to a Pipeline host computer or via a single enterprise class, fully non-blocking professional-quality Ethernet switch via CAT6 Ethernet cabling. Multiple hops via routers and switches increase the risk that video frames will not be processed in a timely manner resulting in lost frames. It is highly recommended that the Pipeline host's network adapter be based on Intel Gigabit cards.

Capturing across multiple switches or routers is possible with Pipeline only when the link is a full 1 gigabit. Always consult with your network administrator when attempting to utilize Pipeline across multiple switches, networks or VLAN's.

Recommended network switches:

- Extreme Networks
- Force 10, Cisco
- Foundry (Brocade)

Use of a private Pipeline video VLAN is highly recommended.

Special care must be taken to insure that Pipeline real-time processes can be achieved. To ensure reliable Pipeline performance, Pipeline must be on a dedicated media network. Operating on a general information network will expose Pipeline to network processes that can consume unbounded bandwidth and excessive network stack cycles which can cause Pipeline real-time streams to be interrupted. These interruptions can cause Pipeline to become unstable and stop operating.

- Pipeline Encoders and Pipeline Control host machines should not be connected to a general information network. If operating Pipeline on a general information network the recommended procedure is to

reboot Pipeline once per week (every seven days) as part of your standard system maintenance. Not doing this recommended procedure may cause Pipeline to stop operating.

- If Pipeline is operating on a dedicated media network with adequate bandwidth there is no need to perform the recommended weekly reboot procedure.
- The Pipeline Control host machines should be dedicated to running Pipeline Control and should not have other applications or services installed.

The best practice is to separate Pipeline traffic from data traffic by using more than one network adapter within the Pipeline host computer. Design your system with one (or more) Ethernet ports dedicated to the incoming Pipeline streams and separate Ethernet port(s) for general data and media delivery traffic.

As a rule of thumb, never exceed 50% usage of any one Ethernet port or network switch. For example when capturing Pro Res 422 HQ at 220Mbps use one GigE Ethernet port for every two (2) streams. Multiple port Ethernet is required for this purpose.

Network examples

Figure 4–1. Eight channel Pipeline SD capture system

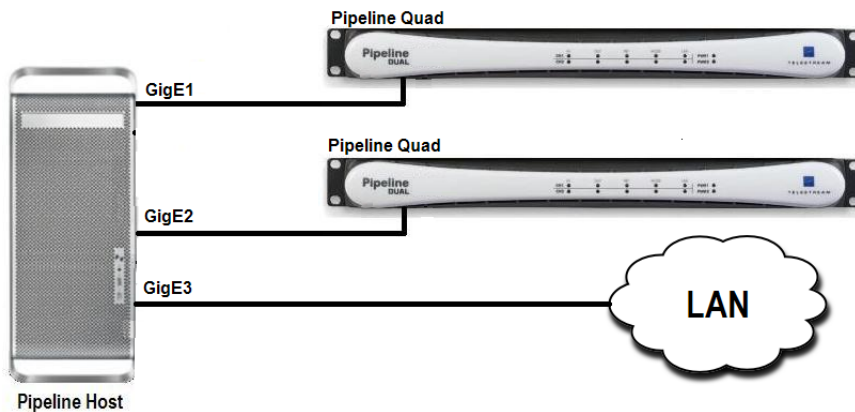
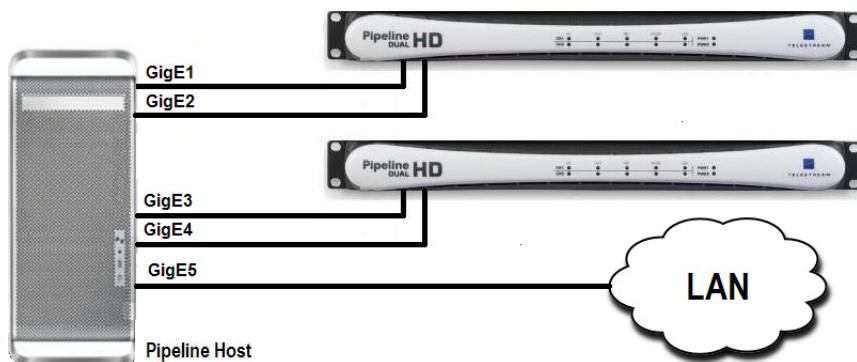

Figure 4–2. Four channel Pipeline HD capture system



Capture-only Workflows

For capture-only workflows, when writing to internal or direct attached (non-shared) RAID arrays, you only need to calculate the overall write speed requirements. Configure your media storage array based on the write performance required for the number of streams being captured.

Figure 4–3. Configuration for capturing 4 HD streams onto Fibre-attached storage.

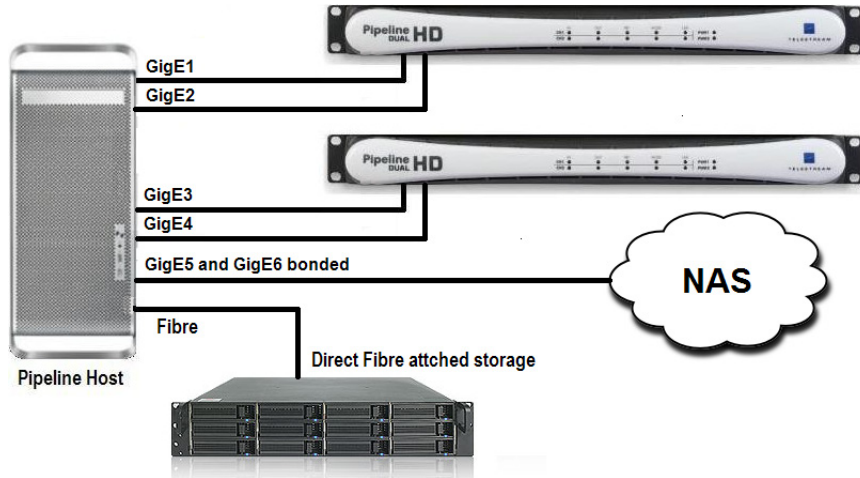

Concurrent Edit/Transcode Workflows

For capture with concurrent edit or transcode workflows, calculate the total read/write speed requirements based on the write processes of Pipeline streams and read processes for edit and transcode operations.



Note

Disk buffering is required when the destination path is located on a NAS, shared network folder, or when edit/transcode while capture operations are to be performed on the incoming Pipeline media files.

Some format wrappers do not support this feature. Take special care when writing these file types to shared disks.

To guarantee error-free operations when writing to NAS, you must use disk buffering. Use an internal or direct-attached non-shared RAID array that meets the read/write performance requirement ([Disk Buffering Details on page 36](#)).

Pipeline's media storage location (NAS, direct-attached shared storage, or shared network folder) must also meet certain read/write performance requirements. When using NAS, direct-attached shared storage or shared network folder, be sure to verify that your system has the communications bandwidth for writing all Pipeline media data to the media storage location in real-time.

For SD, Telestream recommends that the host's disk storage system provide and maintain a sustained 10 MB/sec. transfer rate per stream from the Pipeline host computer to the media disk (read/write).

For DVCPRO HD, ProRes 422/SQ/LT/Proxy and standard quality DNxHD, Telestream recommends that the Pipeline host's disk storage system provide and maintain a sustained 40 MB/sec. transfer rate per stream from the Pipeline host computer to media disk (read/write). For ProRes 422 HQ and high quality DNxHD, Telestream recommends at least a 50 MB/second sustained transfer rate.

Capture Workflows Utilizing NAS|Direct-Attach Storage|Network Folders

For capture writing to NAS, direct-attached shared storage or shared network folder, you should enable Pipeline disk buffering ([Disk Buffering Details on page 36](#)).



Note

Disk buffering is required when the destination path is located on a NAS, a shared network folder, or when edit/transcode while capture operations are to be performed on the incoming Pipeline media files.

Some format wrappers do not support this feature. Take special care when writing these file types to shared disks.

Disk buffering requires a separate RAID array to guarantee error-free write operations of media streams.

Figure 4–4. Configuration for capturing four HD streams onto NAS with Fibre-attached buffer.

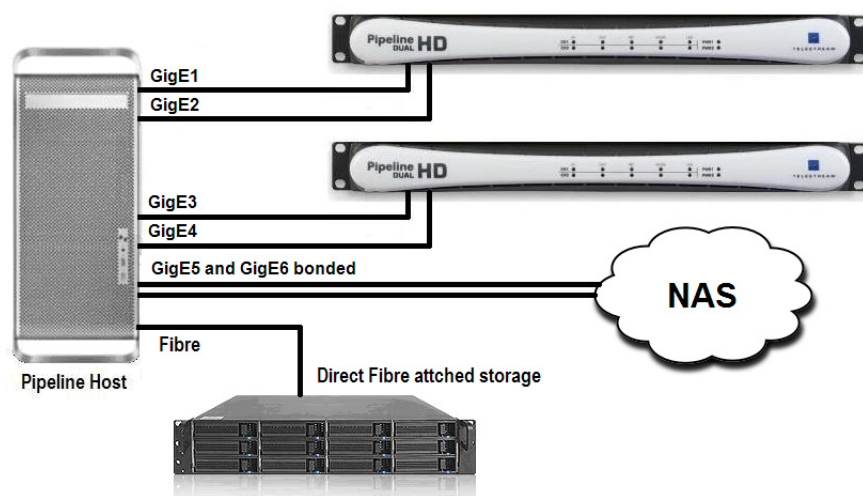

When calculating disk buffer RAID array read/write performance requirements, you should use two times the required Pipeline streams write requirements. This is required to support a write and a read operation on the data buffer array for each Pipeline stream.

The Pipeline's media storage location (NAS, direct-attached shared storage or shared network folder) must meet the write performance requirements. When using NAS, direct-attached shared storage or shared network folder, be sure to verify that your system has the communications bandwidth for writing all Pipeline media data to the media storage location in real-time.



Caution

Capturing video is a disk intensive operation. It is important that you create a system with adequate disk performance for writing and reading real-time video files. In addition to the information provided below, make sure that the disks used for Pipeline operations are defragmented often. A fragmented drive can decrease performance and may cause capture and playout operations to fail.

Pipeline Media Storage

In determining storage requirements, there are two main factors to consider – the overall sustained read/write performance and local data disk buffering.

To ensure performance and quality, the disk storage systems used with the Pipeline host computer must be able to meet the demands of reading and writing one or more real-time SD and HD media streams.

For SD, Telestream recommends that the Pipeline host's disk storage system provide and maintain a sustained 10 MB/sec transfer rate per stream from the Pipeline host computer to the media disk (read/write).

For DVCPro HD, ProRes 422/SQ/LT/Proxy, and standard quality DNxHD, Telestream recommends that the Pipeline host's disk storage system provide and maintain a sustained 40 MB/sec transfer rate per stream from the Pipeline host computer to media disk (read/write) for each stream. For ProRes 422 HQ and high quality DNxHD, Telestream recommends at least a 50 MB/sec transfer rate for each stream.

To evaluate your needs, first take into account the data rate for the format that you'll be using and the number of streams your system will be capturing concurrently. [Disk and Network Requirement by Media Format on page 38](#) provides approximate data rates for a variety of formats and resolutions. Use these tables to calculate the overall read/write performance requirements for your main storage disk system and if needed for your local data buffering storage disk system.

Capture-only, writing to internal or direct-attached RAID array. For systems utilizing internal or direct attached (non-shared) storage for capture only operations, you only need to calculate the overall write speed requirements. Configure your media storage array based on the write performance requirement for the number of streams being captured.

Figure 4–5. Four channel Pipeline HD with direct attached Fibre RAID storage

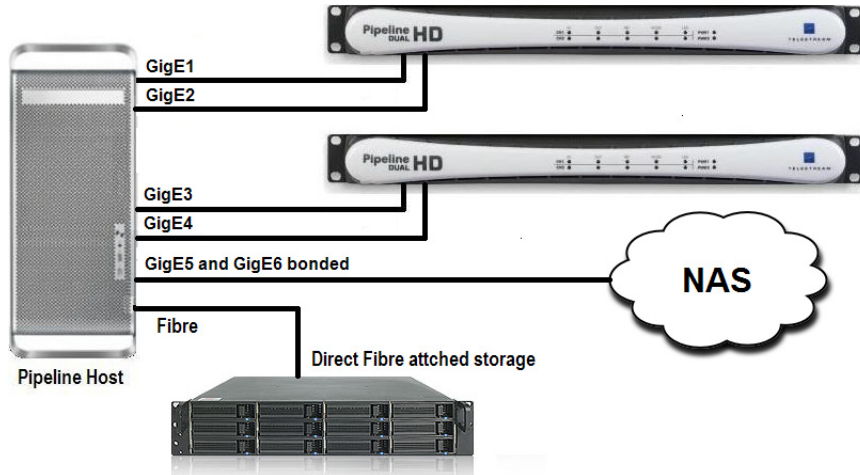

Capture with concurrent edit or transcode. For systems that are capturing with concurrent edit or transcode operations, you should calculate the overall read/write speed requirements based on the write processes of Pipeline streams, and the read processes for the edit and transcode operations. To guarantee error-free operations you must use Pipeline's data buffering feature utilizing an internal or direct attached non-shared storage RAID array for data buffering that meets the desired read/write performance requirement (see [Disk Buffering Details on page 36](#)). The Pipeline's media storage location (NAS, direct attached shared storage or shared network folder) must also meet these minimum read/write performance requirements. When using NAS, direct attached shared storage or shared network folder, be sure to verify that your system has the communications bandwidth for writing all Pipeline media data to the media storage location in real-time.

Capture writing to NAS, direct attached shared storage or shared network folder. For systems that are capturing media written to a NAS or shared network folder, the Pipeline data buffering feature must be enabled (see [Disk Buffering Details on page 36](#)). Data Buffering requires a separate data buffer RAID array to guarantee error-free write operations of Pipeline media streams. Calculating the disk buffer RAID array read/write performance requirements use 2X the required Pipeline streams write requirements. This is needed to support a write and a read operation on the data buffer array for each Pipeline stream.

The Pipeline's media storage location (NAS, direct attached shared storage or shared network folder) must meet the minimum write performance requirements. When using NAS, direct attached shared storage or shared network folder, be sure to verify that your system has the communications bandwidth for writing all Pipeline media data to the media storage location in real-time.

Figure 4–6. Four channel Pipeline HD with direct attached data buffer RAID

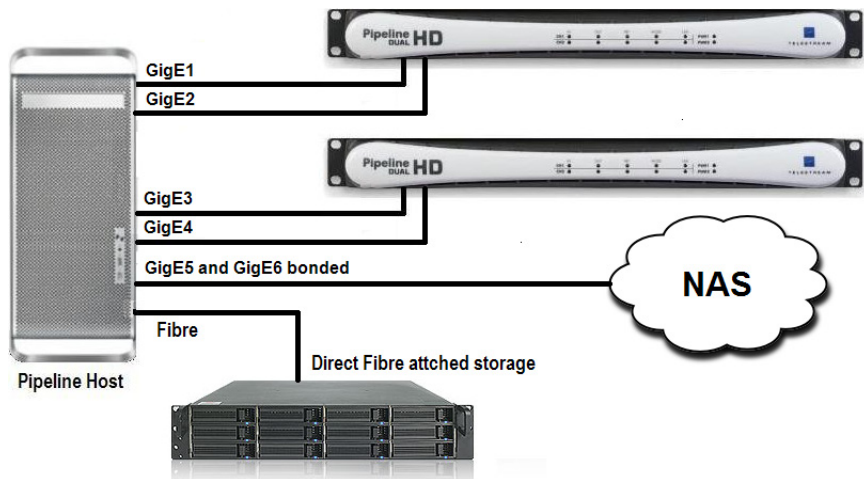

Example Systems

Distributed Pipeline model. Individual workstations controlling individual channels, each workstation meeting the Pipeline channel specification with a network to support all traffic:

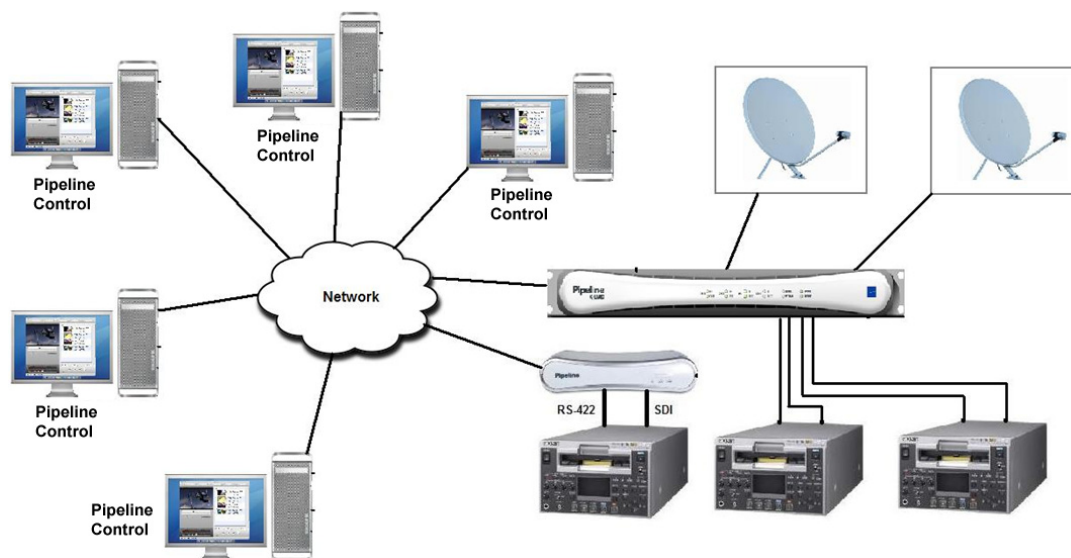

Centralized Pipeline ingest model. A central workstation controlling multiple Pipeline channels. The central workstation meets the multiple Pipeline channel specification with a network and storage system to support the workflow:

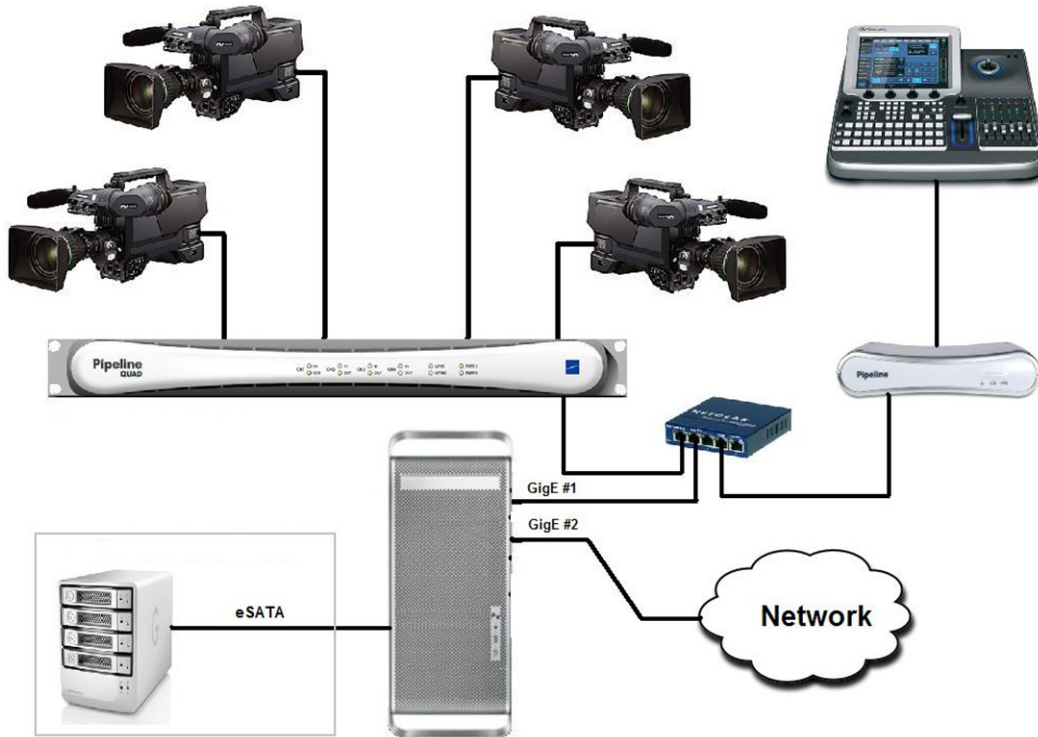

Four channel HD with data buffering. Four channels of HD hosted by a central workstation with delivery to a NAS. Data Buffering is enabled through directly attached RAID storage:

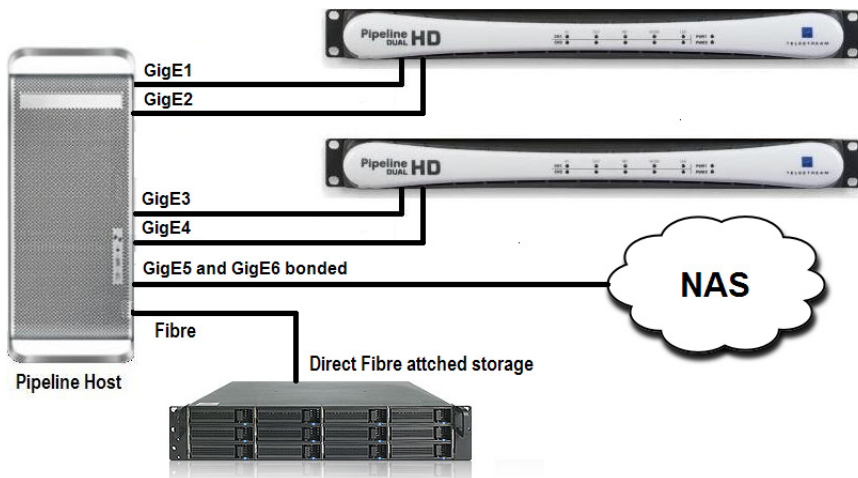

Multiple channel Transcode while capture. Multiple Pipeline channels hosted by a central workstation with delivery to a directly attached storage device. The storage is shared to the transcoding servers for concurrent processing:

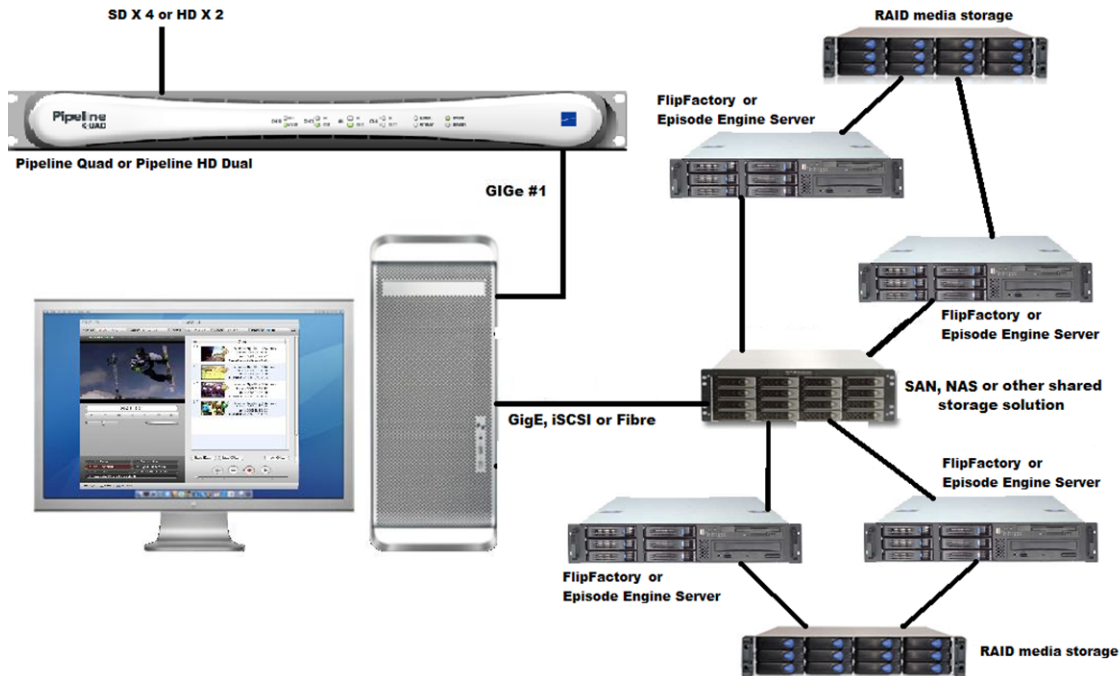

Multiple channel edit while capture. Multiple Pipeline channels hosted by a central workstation with delivery to shared storage device. Internal 15K RAID array is used as a Disk Buffer in case the shared storage cannot maintain real time writes:

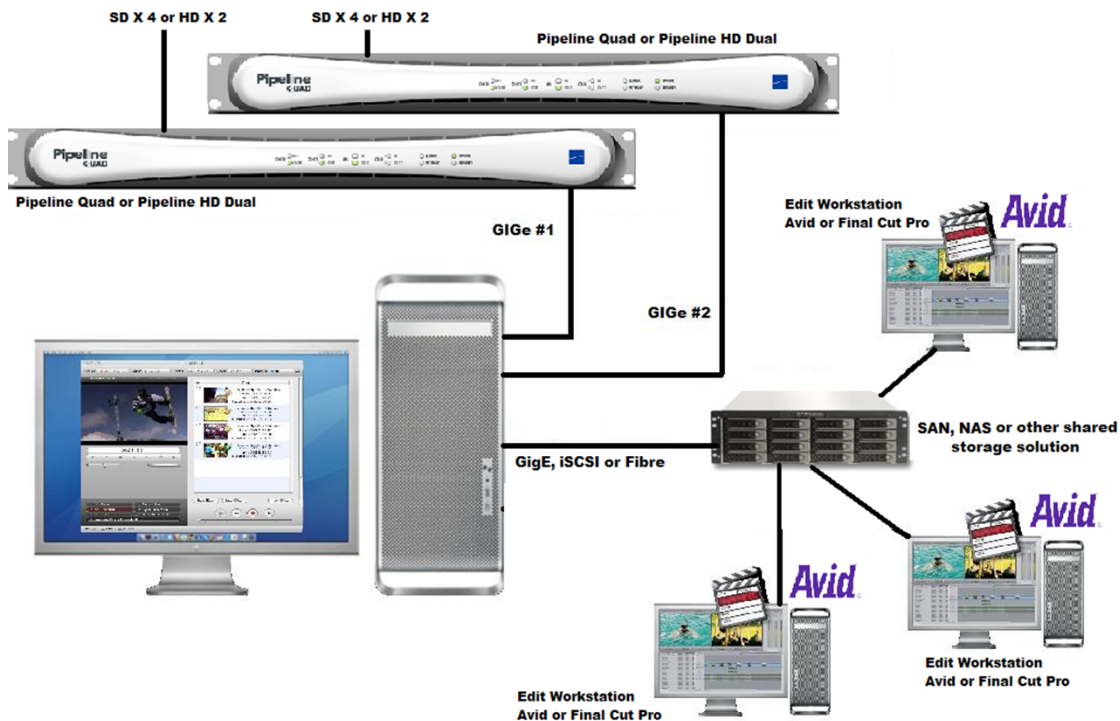

DISK BUFFERING DETAILS

When Disk Buffering is checked, video and audio data are written into a FIFO disk buffer file in a local folder before the data is written to the media file destination.



Note

Disk Buffering must be enabled when the destination path is located on a NAS, a shared network folder, or when edit/transcode while capture operations are to be performed on the incoming Pipeline media files.

During capture operations, when the file destination drive's performance is reduced due to additional read processes (when performing transcoding, file editing or other disk-intensive activity), data is placed into the FIFO (First In, First Out) buffer.

Figure 4-7. FIFO disk buffering enhances file writing performance

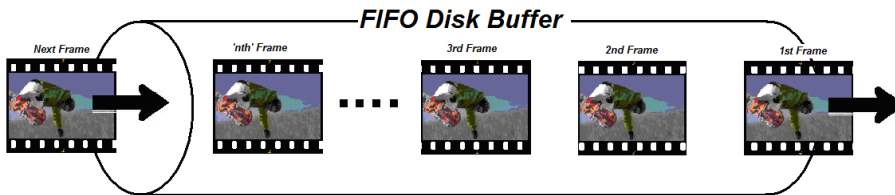

Disk buffering prevents the RAM buffer from overflowing when disk writes are temporarily blocked or performance is reduced on the media file destination disk.

The read/write performance for a volume used for disk buffering needs to be able to support the media format and number of channels being captured. As a rule of thumb, the buffer disk should be RAID-0 with the appropriate number of drives to support the read and write requirements for the number of channels with the respective media format used ([Disk and Network Requirement by Media Format \(page 38\)](#)).



Note

The disk used for buffering should be used exclusively for Pipeline buffering. Using the disk buffer drive for other read/write processes may cause unpredictable results.

Enable Disk Buffering whenever your media file destination is not a local drive or array – such as a NAS, or shared network folder.

Figure 4-8. Pipeline buffering process

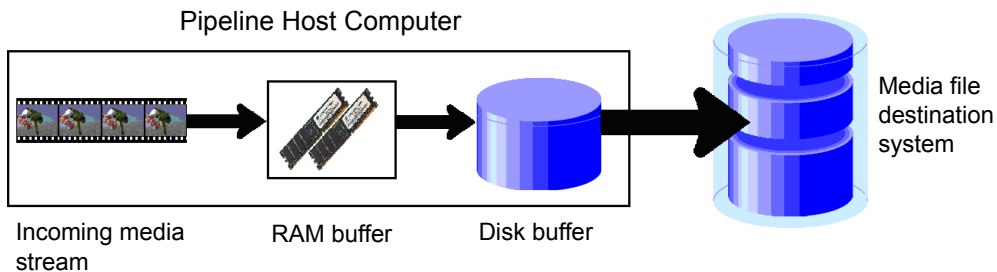



Caution

The disk selected for buffering should be used exclusively for Pipeline video/ audio data buffering. Using the disk buffer drive for other read/write processes may cause unpredictable results.

Never write to a disk buffer that does not meet the minimum performance requirement for the number of channels and media format being captured. See [Disk and Network Requirement by Media Format \(page 38\)](#).

The disk buffering drive must never be the same as the media file destination drive. This will result in doubling the amount of read and writes operations to this drive and will severely degrade overall disk performance.

When schedule events are touching (one file stops and the other starts at the same moment) and there is a handle setting of more than zero, the amount of data being processed and written to disk doubles for the duration of the handle.

Double capturing may result in data loss in workflows on slow computers, or in workflows with multiple simultaneous ingests, since the application may be pushing the limits of CPU capacity or disk write speed.

PLATFORM AND SYSTEM REQUIREMENTS

General Pipeline Host System Requirements

- Pipeline firmware v2.6 or later
- CPU: Intel Core 2 Duo, Intel Quad Core, or greater
- Operating System:
 - Mac OS X Version 10.6 (Snow Leopard). Requires QuickTime Version 7.5.5 or newer with ProRes decoder component.
 - Windows 7 Pro 64 bit, Windows Server 2008 R2. NET Framework v3.5 SP1
- Video card with minimum 256MB RAM (for Mac OS X - card must support Quartz Extreme/OpenGL accelerated surfaces and be attached to a compatible video display)
- GigE or faster Ethernet adapter
- Final Cut Pro Version 5.0.1 or newer is required when using Pipeline plug-in

System Requirements for FlipFactory Pipeline Workflows

FlipFactory supports workflows utilizing Pipeline SD systems.

- FlipFactory v6.0 with Update Packs 1-5 or FlipFactory v6.1
- Concurrent Pipeline ingest streams may vary depending on CPU and disk speeds
- Recommended server spec:
 - Dual 2.3Ghz (or higher) Intel Quad Core CPU
 - Dedicated RAID-0 media storage
 - 2GB RAM

PIPELINE HOST COMPUTER RECOMMENDATIONS

Network and Hard Disk Performance Requirements (per stream)

Table 4–2. Disk and Network Requirement by Media Format

CODECS	Disk Read/Write Mbps	Network Throughput Mbps	Storage (per hour) Required for 8-Channel Audio
SD Codecs			
Motion JPEG A	0.75	8	5GB
DV/DVC Pro	4.4	35	15GB
IMX30	5.3	43	16GB
IMX40	7.0	56	20GB
IMX50/DVCPro50	8.3	67	25GB
ProRes422 SQ	7.3	58	21GB
Uncompressed 8-bit 422	22	175	80GB
HD Codecs (range based on codec and bit rate)			
DVCPro HD	16.5	135	73GB
ProRes 422 HQ	10-36	62-240	50-100GB
DNxHD	10-36	62-240	50-100GB

Recommended Hardware Systems.



Note

All systems assume media storage local (internal or direct attached) to the host system with adequate storage to support 24 hours of content at the chosen format, and drive array is less than 80% full without serious fragmentation.

General guidelines

CPU

- Single or Dual channel systems: Dual Dual Core 2.3Ghz CPU or faster
- Three or Four channel systems: Dual Quad Core 2.3Ghz CPU or faster
- Four or Five channel: Dual Six Core 2.3Ghz CPU or faster

RAM: 4GB RAM per channel

Operating System: Check Telestream web site for the latest supported OS

Media Storage: Sustained read and/or write speeds (separate from OS drive)

- Capture only: 40MB/s per channel
- Play out only: 60MB/s per channel
- Transcode/Edit/Disk Buffering while Capture: 100MB/s per channel



Note

Check the *Pipeline Configuration and Setup Guide* located on the *Pipeline Support* page <http://www.telestream.net/telestream-support/pipeline/support.htm> for more details on system configuration and setup.

Edit while ingest and transcode while ingest workflows require increased disk I/O performance to support the additional read processes, and may require disk buffer cache drive system (see Pipeline User Guide disk buffering details). Viewing HD preview stream(s) can consume high levels of CPU which may cause dropped frames. It is recommended that preview be turned off during capture.

CHAPTER 5

Using Pipeline Administrator

Pipeline Administrator is a Web application embedded in each Pipeline, which enables you to connect to Pipeline devices on your network with a Web browser.

You can use Pipeline Administrator to perform administrative tasks on the Pipeline, including network configuration and firmware upgrades.

Topics

- [Supported Web Browsers \(page 41\)](#)
- [Launching Pipeline Administrator \(page 42\)](#)
- [Using Pipeline Administrator \(page 41\)](#)
- [Using the About Panel \(page 43\)](#)
- [Using the Configure Panel \(page 44\)](#)
- [Using the Quad Panel \(page 50\)](#)
- [Using the Counters Panel \(page 53\)](#)
- [Using the Upgrade Panel \(page 55\)](#)

SUPPORTED WEB BROWSERS

You can configure Pipeline using your Browser of choice. However, you may need a plug-in for Bonjour if you want to discover Pipelines automatically.



Note

Web browsers are supported only on the platform specified. You may encounter situations where features may not function correctly in all cases. In particular when running Windows 7 or Windows Server 2008 with Internet Explorer, you may encounter security issues that prevent Pipeline Administrator from displaying correctly or from saving configuration changes. In these cases consult with your IT administrator to adjust the browser's security setting to allow Pipeline Administrator to run properly. Alternatively you can install another browser such as Mozilla Firefox or Google Chrome as your default.

You can run Pipeline Administrator from anywhere on your network. You can run it directly on a Pipeline host system or any computer with visibility to the Pipeline device.

LAUNCHING PIPELINE ADMINISTRATOR

The Pipeline Administrator can be accessed through a web browser. To connect to a Pipeline and launch Pipeline Administrator perform one of the following steps:

- **Using a known Pipeline channel IP address:** Open a web browser and enter the IP Address in the browsers address bar.
- **In Mac OS X:** Open Safari and select Bookmarks > Show All Bookmarks. In the Collections panel, click Bonjour. From the list of available devices double-click the Pipeline you wish to connect to, to display Pipeline Administrator.
- **In Windows:** Open Pipeline Control and select any document type (Schedule, Log and Capture, Trigger, Print-to-Tape or Controlled Playout). Select the Pipeline you wish to connect to from the Pipeline dropdown list. Open the Diagnostics panel and click on the Administer button. This will open the selected Pipeline's Administrator page in your default browser.

If this is the first time connecting to this Pipeline since starting the browser, and if the Pipeline is password-protected (configure panel > Security), the browser displays a Pipeline Authentication dialog. Enter the username (always *administrator*) and a password (if you added one), and click OK to connect to the Pipeline and display Pipeline Administrator:

Figure 5–1. Connect dialog – enter your username and password to connect

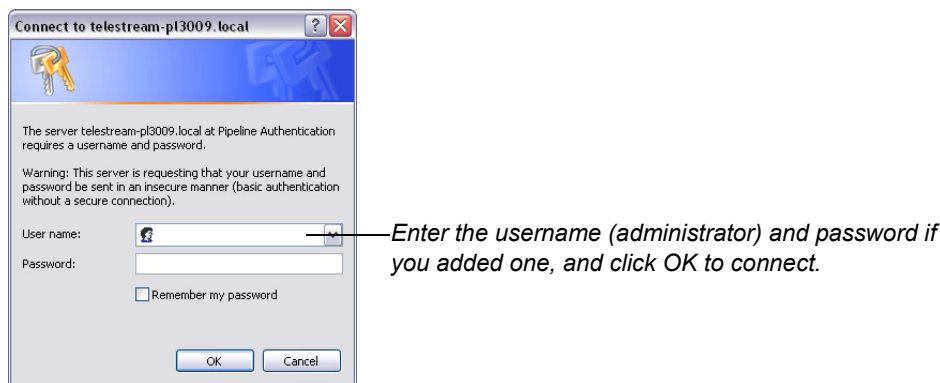

USING PIPELINE ADMINISTRATOR

Pipeline Administrator has several panels you can use to perform various tasks:

- **Using the About Panel** – provides general information about Pipeline and registration.
- **Using the Configure Panel** – displays Pipeline and network settings, allows you to change network settings and options.
- **Using the Quad Panel** – displays when connected to a Pipeline Quad, to control confidence monitoring.
- **Using the Counters Panel** – displays statistical information about Pipeline activity.
- **Using the Upgrade Panel** – enables you to upgrade the firmware and Pipeline Administrator.

You can access the Pipeline User's Guide (the document you are currently reading) from each panel by clicking the User's Guide link at the bottom of each panel.

USING THE ABOUT PANEL

To display the About panel, click **about** in the menu bar at the top of the window:

Figure 5–2. The About panel displays a link to product registration.

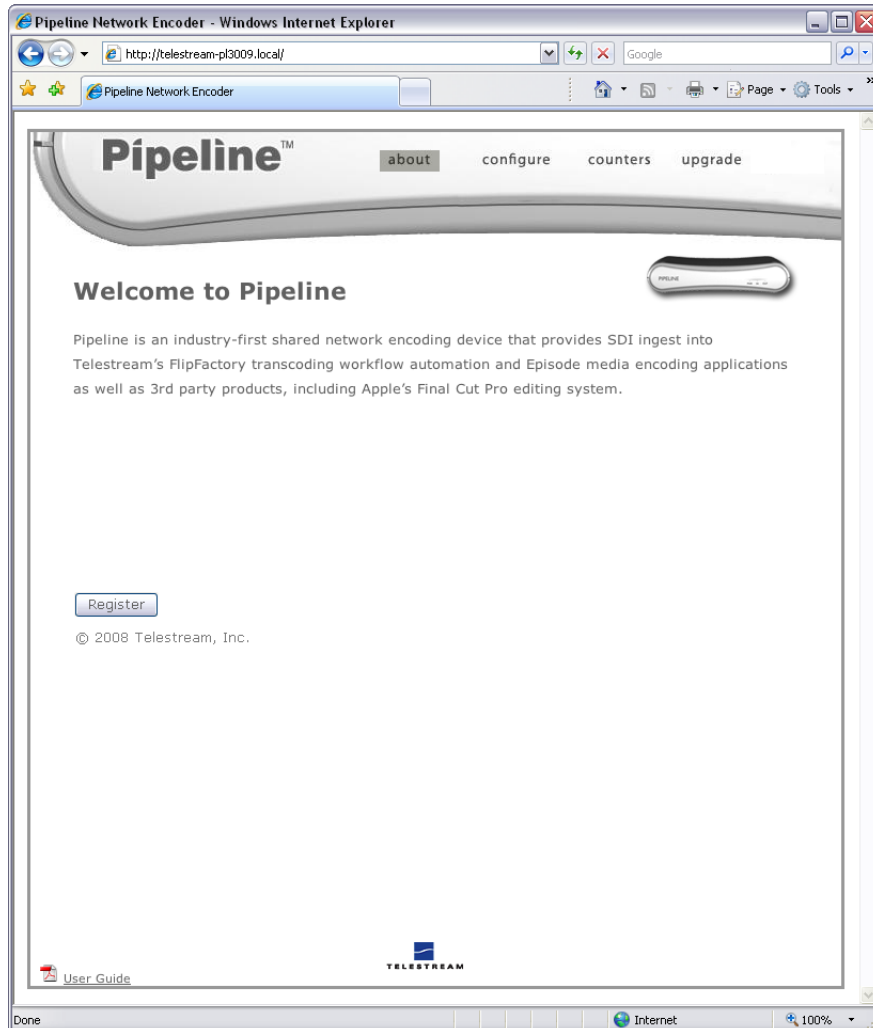

Register the Pipeline by clicking the Register button. Follow the steps on the Web page to complete registration. If you've already registered this Pipeline, the Register button no longer displays.

If the computer you're using is on a LAN without Internet access, use a computer that has Internet access and go to dynamic.telestream.net/pipeline-register/register.asp to register your Pipeline. You should register your Pipeline to ensure ongoing warranty service and customer support.

The About panel – as well as the other panels – provides online access to the Pipeline User's Guide (this document), by clicking the link in the lower left corner.

Using the Configure Panel

To display the Configure panel, click **configure** in the menu bar at the top of the window:

Figure 5–3. Configure panel displays details & allows you to change settings

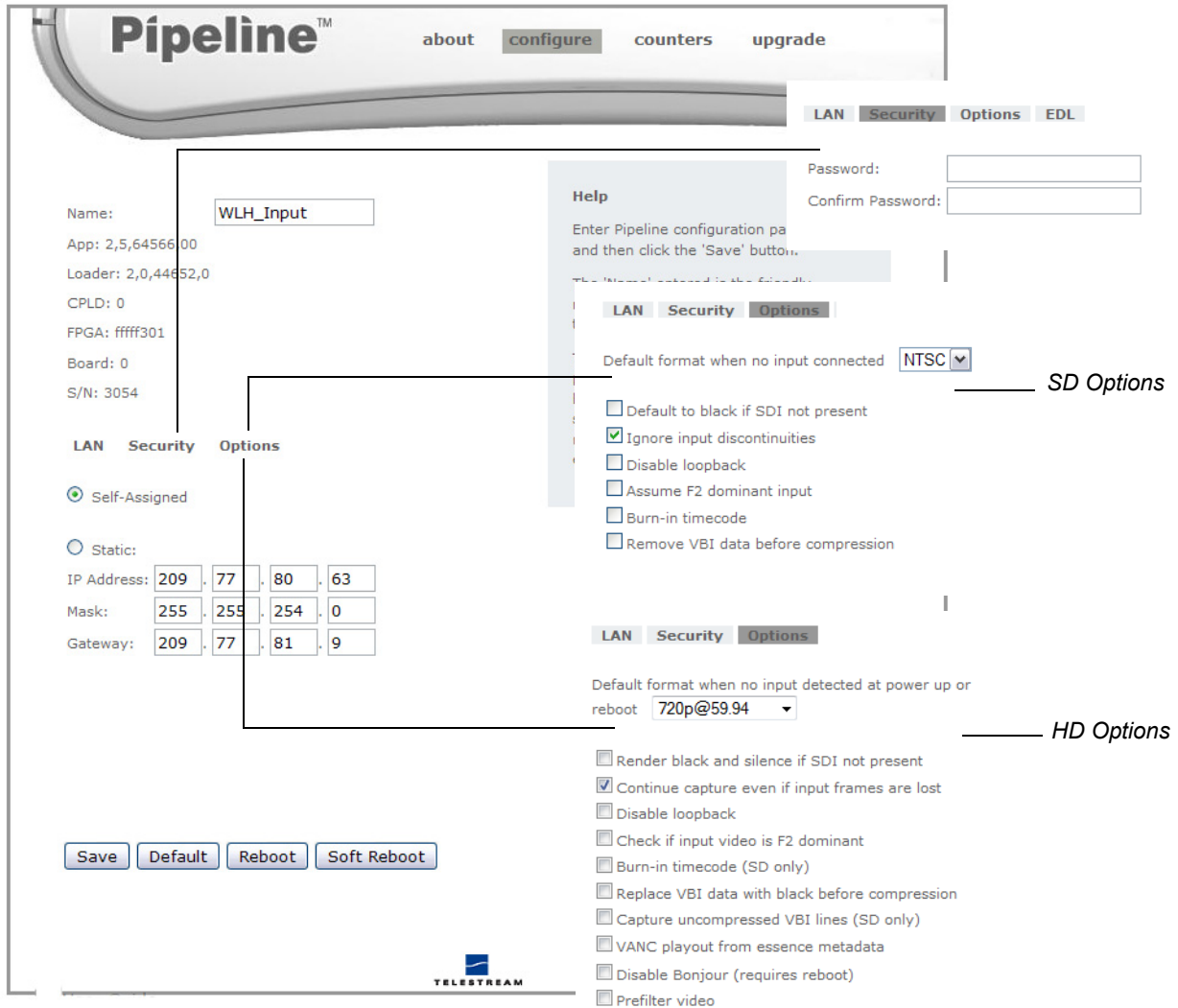

Use the Configure panel to view and make changes to Pipeline's identity, IP settings, and options. Click the LAN, Security, Options, and EDL toolbar to view their respective control panels, as shown in the callouts in the figure above. Each control is described in the following table:

Table 5–1. Configure Panel controls and descriptions.

Control	Description
Pipeline Identity	
Name	<p>Editable field. Default for Pipeline SC: <i>Pipeline-XXXX</i>, where <i>XXXX</i> is the serial number printed on the bottom of the Pipeline.</p> <p>Default for Pipeline Quad: <i>PipelineQuadXXXX_N</i> where <i>N</i> is the device number 1 through 4.</p> <p>Default for Pipeline HD Dual: <i>PipelineHDDual_XXXX_N</i> where <i>N</i> is the device number 1 through 2.</p> <p>To change the name, enter a new name, and click Save Changes. The name is updated in the Pipeline, and is reflected in the Bonjour panel. Limit: 255 characters.</p> <p>If you enter a friendly name that already exists, Pipeline adds (1), (2.), as necessary to maintain uniqueness.</p> <p>For best naming practices, you should identify the Pipeline model (SC or Quad), uniquely name it, and, in the case of the Quad, refer to the channel number. For example, <i>PipelineQuad_Prod7_Channel2</i>.</p>
App (firmware version)	<p>Displays Pipeline's firmware version number, composed of <Major Version>,<Minor Version><Build Number>,<Channel Number Identifier>. For example: 2,2,33165,00 indicates Version 2.2, Build 33165, channel 0. On Pipeline SC, the channel number ID is always 0. Upgrades are identified by major version and minor version numbers: 2.2, for example.</p>
Loader (version)	<p>Displays Pipeline's boot loader version number, composed of <Major Version>,<Minor Version><Build Number>,<Channel Number Identifier>.</p>
CPLD Version	CPLD chip version number on the Pipeline, for Telestream use.
FPGA	FPGA chip version number on the Pipeline, for Telestream use.
Serial Number	Four digit serial number of the device, not changeable.
LAN	
	<p>When changing the IP address, you should click Save Changes to update the Pipeline, then close Internet Explorer or Safari. Wait about 30 seconds, then restart your Web browser and log back on. If you don't, your Control application will behave incorrectly, and Pipeline Administrator will periodically display an error: "Can't communicate with Pipeline".</p>
Self-Assigned	Select to utilize the default link-local IP address, generated based on the Pipeline's serial number; incremented on Pipeline 2, 3, and 4 on Quad.
Static	Select to use the IP address, subnet mask, & gateway, entered manually.
IP Address	Enter the IP address assigned by your network administrator.
Mask	Enter the subnet mask assigned by your network administrator.
Gateway	Enter the gateway address provided by your network administrator.
Security	

Control	Description
Password	Editable field. No password is assigned by default. (Username is always <i>administrator</i> .) Limited to 15 characters; standard HTTP password rules apply. May be empty to disable authentication.
Confirm Password	Editable field. Enter second time to confirm.

Control	Description
Options	
Default format when no input connected	Select the default format from the menu. On HD Pipelines, you can choose an SD NTSC PAL or various HD 720 1080 profiles. On SC/Quad Pipelines, choose SD NTSC PAL. If the channel boots with no SDI input it will default to the value specified here. If the channel is already running with SDI input, selecting this setting will do nothing until the next time it boots without SDI input. If the channel is already running with SDI input and the input is removed, selecting a setting and clicking the save button will set the channel to the selected format. Note: <i>If play out of 1080PsF at 23.98/24fps is desired you must select 1080psf@23.98.</i>
Default to black if SDI not present (SD units) / Render black and silence if SDI not present (HD units)	Pipeline generates a test pattern when SDI input signal is not present. If this option is checked, the test pattern is a black frame. Otherwise, the generated test pattern is color bars. The pattern is generated in NTSC or PAL (or HD formats on HD Dual), based on the Pipeline mode. The last valid SDI signal sets the mode, unless there is no SDI present when it boots. In this case it reverts to the setting specified above. Audio is muted when this option is checked.
Ignore input discontinuities (SD units) / Continue capture even if input frames are lost (HD units)	Unchecked by default, to insure capture quality. Check when you do not want Pipeline to report missing/partial frames in input stream during capture. This is useful if, for example, you are capturing from a satellite feed or an unreliable SDI signal where errors occur more often and you do not want Pipeline to report an input error causing the capture session to abort the capture.
Disable loopback	Prevents input SDI from being present on the output SDI during capture. Consider enabling when exporting (or capturing) to a deck and the deck complains about the reference signal. Note: <i>Due to hardware limitations it is never fully disabled. Even a small amount of signal causes some decks to complain. If this happens the user should physically remove either the SDI input or output (depending on capture or playout) from either the video source or the Pipeline.</i>
Assume F2 dominant input (SD units) / Check if input video is F2 dominant (HD units)	When checked during encoding, Pipeline constructs a frame by using a field pair consisting of an F2 field followed temporally by an F1 field. This is in contrast to normal operation, which constructs a frame using a field pair consisting of an F1 field followed temporally by an F2 field.
Burn in Timecode (SD capture only)	When checked, Pipeline overlays the timecode it is using as its primary clock on the video image. This option applies for SD codecs only.
Remove VBI data before compression (SD units) / Replace VBI data with black before compression (HD units)	When checked, Pipeline strips each frame of VBI data, replacing it with black before passing it to the encoder for compression.
Capture uncompressed VBI lines (HD units only)	When checked, Pipeline passes the Uncompressed VBI data contained in an SD SDI signal to the control software to be included in appropriate output formats.

Control	Description
VANC playout from essence metadata (HD units only)	Check this option if you wish to play out the VANC data contained in the video essence of the file. This option overrides the play out of track based VANC metadata contained in QuickTime Closed Caption tracks or MXF SMPTE-436M packets.
Disable Bonjour (HD only)	Check this option to disable all Bonjour communication on this Pipeline channel. The channel will no longer transmit or listen for Bonjour traffic. Use this option in conjunction with the Discovery Option within Pipeline Control for Windows (see Discovery Tab on page 86).
Prefilter Video (HD only)	This option applies a softening filter to non-full raster codecs (DVCPProHD, MJPEG, ProRes 1440). This option will apply an effect that will smooth sharp edges and can improve picture quality. Apply this filter if this effect is desired. Full raster codecs are not affected by this filter.

Control	Description
EDL	
Use IP address instead of Pipeline name	Check when you want communication to utilize the IP address of the Pipeline, instead of using the Pipeline name and resolving it via Bonjour.
Signal to abort on dropped frames	Check when you want FlipFactory to abort the capture process if a dropped frame occurs.
Buttons	
	If another user is connected and processing media with this Pipeline, using these buttons will interrupt the process, and it must be re-started.
Save Changes	Click to update the Pipeline with the new settings. If you change the IP address (by any means – returning to self-assigned, enabling DHCP, or assigning a static address), in about 30 seconds, Pipeline Administrator displays an error: “Unable to communicate with Pipeline”. Click OK, then reconnect to the Pipeline using the new IP address.
Default	Return settings to default. After returning the settings to default, be sure to click Save to make the settings take effect.
Reboot	This reboot performs a hardware-level reset, which disconnects Pipeline from any client which may attach without warning. You are warned if you attempt to reboot the channel while it’s in use. Click to reboot the Pipeline if you change the password, to log on using the new password. You do not need to reboot when changing IP settings.
Soft Reboot	This reboot resets the Pipeline and any clients WILL lose their connection. Pipeline Administrator displays an alert to warn you. In cases where the Pipeline is non-responsive, click Soft Reboot to clear the problem.



Note

Always exit Pipeline Control before changing any parameters. If you leave it open and rename channels (or IP's), it will create duplicates in the UI. This can result in wrong channel connections.

Using the Quad Panel

The Quad panel only displays when Pipeline Administrator is connected to one of the Pipeline channels on a Pipeline Quad. When you're connected to any other Pipeline device, this page does not display.

To display the Quad panel, click **quad** in the menu bar at the top of the window:

Figure 5–4. Quad panel controls confidence monitoring

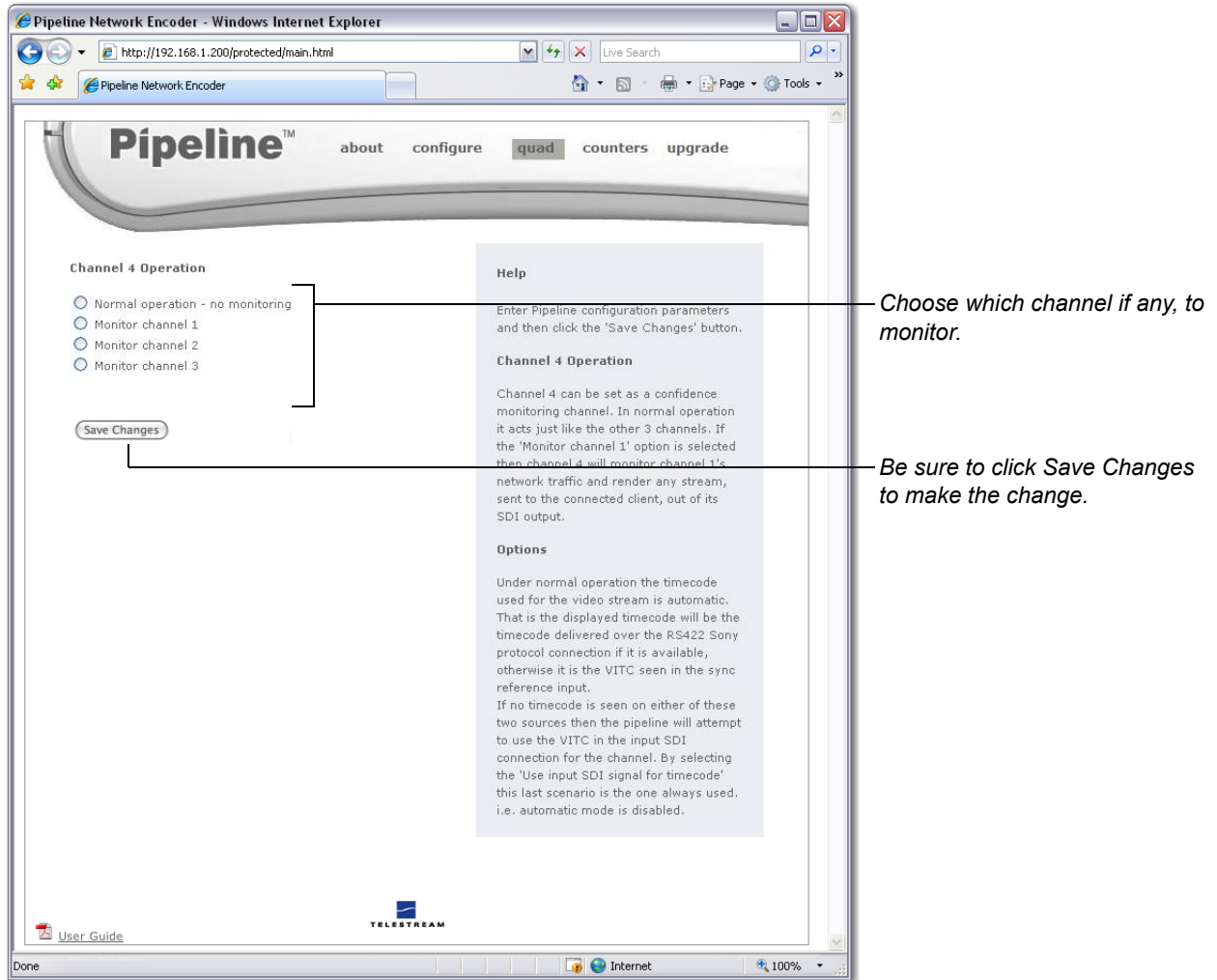

Use the Quad panel to set up confidence monitoring.

Table 5–2. Configure Panel controls and descriptions.

Control	Description
Confidence Monitoring	
Normal Operation – no monitoring	Check to disable confidence monitoring. When confidence monitoring is disabled, channel 4 (Pipeline 4 on the Quad) operates normally, and can be used for capture/payout operations. Note: This option is only enabled when you log on to channel 4. You cannot make this change from other channels.
Monitor channel 1 2 3	Check to enable confidence monitoring and encode and send the rendered stream of the selected channel on channel 4 SDI Out as well. Click Save Changes when you're done to update the settings.

Confidence Monitoring

Confidence monitoring is the process of employing channel 4 on the Pipeline Quad to sniff the exact same video packets being captured from any of the other Pipeline channels on the Quad and processed by the client application during a capture operation (crash recording), for the purpose of verifying that the output is a true representation of the input, or that the output meets certain quality limits or other metrics.

Confidence monitoring can be enabled when you are performing a capture operation or crash recording from channels 1, 2, or 3 on a Pipeline Quad. When enabled, Pipeline 4 is also dedicated to the capture operation for the duration of the capture operation.

Figure 5–5. Confidence monitoring is performed by channel 4 via internal Ethernet bridge

Pipeline Quad's Channel 1 is performing a capture operation – decoding SDI from the SDI Input to Ethernet out, to Pipeline Control.

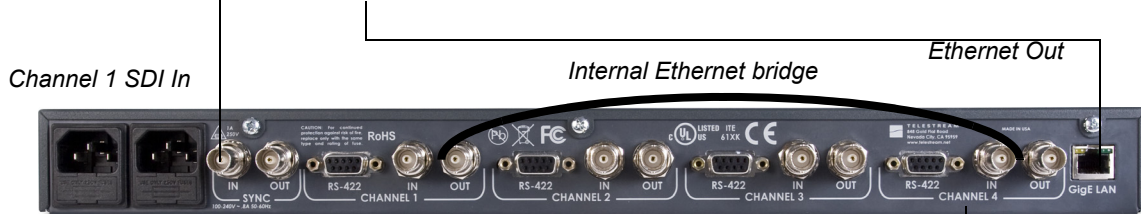

Pipeline Quad

Confidence monitoring of channel 1 enabled.

Channel 4 is confidence monitoring channel 1 – sniffing the outbound traffic on the internal Ethernet bridge and re-encoding it, outputting the resulting SDI on SDI Out for review.

As SDI is being fed into the capture channel's SDI In port, it is encoded and sent out in TCP packets on the Ethernet port to the client application (Pipeline Control, Pipeline Administrator, FlipFactory, Episode, Final Cut Pro, and other media systems). Unlike other confidence monitoring that just re-encodes the media directly in the same device, the channel 4 Pipeline sniffs the very same packets on the Ethernet just as the client does; it then decodes the Ethernet input, and outputs the resulting SDI on its own SDI Out port.

Operators can attach monitors and vector scopes to the SDI out to view and measure the actual media in a full-circle operation, confident that they are testing and viewing exactly the same input as the client system is receiving.



Note

To enable confidence monitoring, you must log on to channel 4 to display the enabled confidence monitoring option on the Quad panel. Channel 4 must be idle before you can enable confidence monitoring. You can confidence monitor both capture operations and crash recording operations.

When confidence monitoring is enabled and the preview media stream from the channel selected is being consumed by Pipeline Control, Pipeline Administrator, or in FlipFactory, the confidence monitor (channel 4 SDI Out) displays black.

If the monitored channel's stream is DV, DVCPPro, IMX, MPEG-2, or ProRes then the confidence monitor displays the full frame video as it is encoded.

If the monitored channel is not streaming media on the LAN, then the confidence monitor displays a banner on the image. The frame background is either the last frame of the previous stream or black.

Figure 5–6. Confidence monitor displays a banner when no media stream is present



Using the Counters Panel

To display the Counters panel, click **counters** in the menu bar at the top of the window:

Figure 5–7. Counters panel displays various processing values

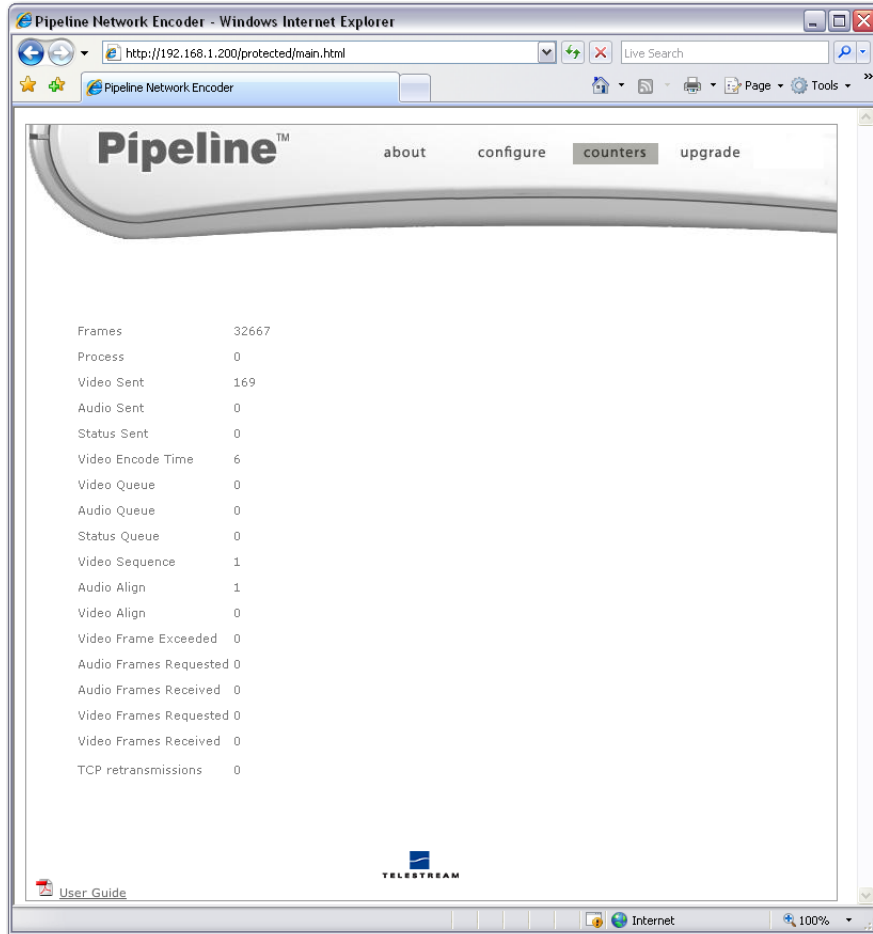

Use the Counters panel to view various values related to encoding and decoding to determine if operations are normal or if there are failures that must be corrected. These values are reset each time a new RTSP connection is made. This information may also be utilized when you are working with Telestream Customer Service to resolve an issue.

Table 5–3. Counters Panel controls and descriptions.

Value	Description
Frames	The number of frames processed during this RTSP session.
Process	The number of frames dropped because of excessive CPU load. If this number is greater than zero, you're losing frames and quality. Determine the cause of the error and reprocess the media.
Video Sent	Number of video frames sent over RTP connection during an capture operation.
Audio Sent	The number of audio frames sent during capture over RTP.
Status Sent	The number of status frames sent during capture over RTP.

Value	Description
Video Encode Time	Number of microseconds it took to process the current video frame.
Video Queue	The number of video frames dropped due to excessive network traffic. If this number is greater than zero, you're losing frames and quality. Determine the cause of the error and reprocess the media
Audio Queue	The number of audio frames dropped due to excessive network traffic. If this number is greater than zero, you're losing frames and quality. Determine the cause of the error and reprocess the media
Status Queue	The number of status frames dropped due to excessive network traffic.
Video Sequence	Count of frames where the timecode (as observed on the RS-422 connection) was not incrementally increasing.
Audio Align	Number of times the audio processor re-synchronized due to an Embedded SDI audio error.
Video Align	Number of times the video processor had to re-synchronize due to an SDI video error.
Video Frame Exceeded	CBR codec error counter.
Audio Frames Requested	During playout, Pipeline requests audio and video frames serially. This is the number of audio frames requested, and should be the same number as Audio Frames Received.
Audio Frames Received	Number of audio frames received during playout.
Video Frames Requested	Number of video frames requested during playout. Should be the same number as Video Frames Received
Video Frames Received	Number of video frames received during playout.
TCP retransmissions	Number of times TCP packets had to be retransmitted.

Using the Upgrade Panel

To display the Upgrade panel, click **upgrade** in the menu bar at the top of the window:

Figure 5–8. Upgrade panel allows you to upgrade Pipeline firmware

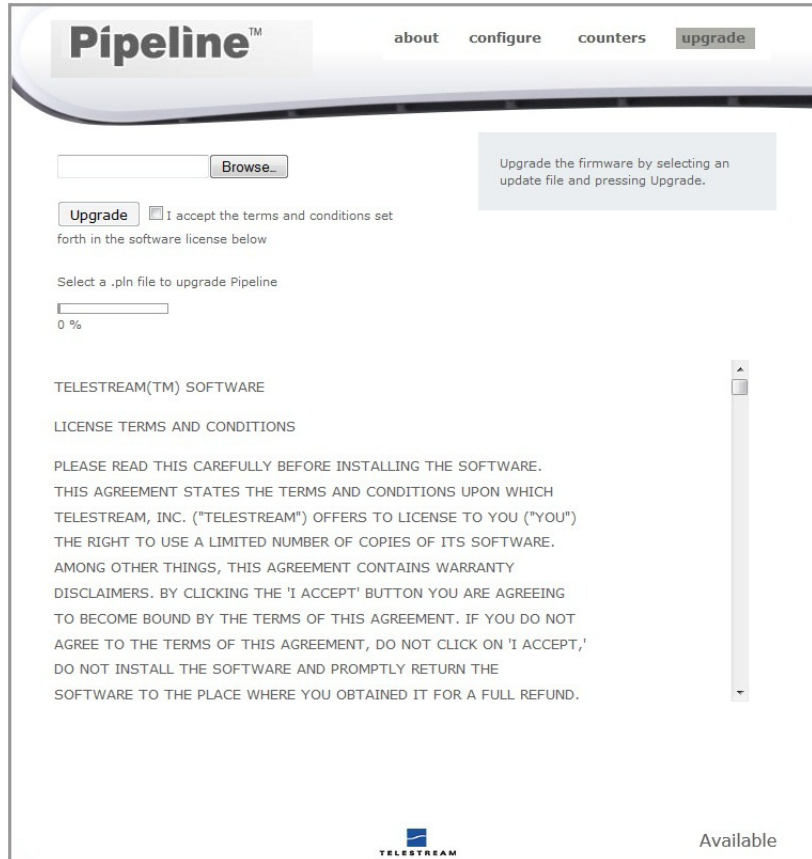

Pipeline is designed so its firmware and Pipeline Administrator Web application can be upgraded easily when new revisions of Pipeline software are made available by Telestream.



Note

To determine the current version of your Pipeline, log on and display the Configure page. The version number is the value in the App field, which displays the firmware version number: <Major Version>, <Minor Version><Build Number><Internal Use>. For example: 2,2,33165,00 indicates Version 2.2, Build 33165.

You can periodically check the Pipeline support page at www.telestream.net/telestream-support/pipeline/updates.htm to determine if there is newer software. (Registered users are notified of upgrades via E-mail.) On the site, click Support > Support Home in the main menu at the top of the page, then select Pipeline > Updates on the right, under Enterprise Product Support. Pipeline firmware updates are available on this page.

To upgrade a Pipeline, follow these steps:

1. Connect to the target Pipeline with a Web browser and determine the current firmware version via the Configure panel ([Using the Configure Panel on page 44](#)).
2. Log on to the Pipeline support page at www.telestream.net/telestream-support/pipeline/updates.htm.
3. Download the Pipeline firmware file (*firmware-xxxxx.pln*) to your computer.

After downloading the firmware file, upgrade the firmware by following these steps:

1. Log on to the target Pipeline using a Web browser.
2. Select Upgrade from the menu to display the Upgrade panel.
3. Click Choose File to locate and select the firmware file (*firmware.xxxxx.pln*) you plan to use.
4. Click Upgrade and observe the progress bar and notes about the process.

During a firmware upgrade, the front SDI In LED (on left) lights yellow during the upgrade process. When the Pipeline has been upgraded, Pipeline Administrator reboots the Pipeline channel and displays a rebooting message on the Upgrade page. In about 15 to 30 seconds, both the In and Power LEDs light green. Pipeline Administrator reconnects automatically and displays the Configure panel.

CHAPTER 6

Using Pipeline Control

Use this chapter to learn about Pipeline Control and how to use Pipeline Control's general features.

Pipeline Control is the host application for controlling digital media capture and play out from Pipeline devices. Pipeline Control is available for both Mac OS X and Windows users. Pipeline control provides different document types to provide log and capture, scheduled capture and play out, triggered manual and automated capture, various types of Print to Tape operations, and Controlled Payout.

Pipeline Control supports both SD and HD – Pipeline SC, Pipeline Quad, and Pipeline HD Dual.

Topics

- [Pipeline Control Overview \(page 57\)](#)
- [Starting Pipeline Control \(page 59\)](#)
- [Creating New Pipeline Control Documents \(page 59\)](#)
- [Pipeline Control Menus \(page 61\)](#)
- [Using The Pipeline Settings Panel \(page 64\)](#)
- [Configuring Publishers \(page 68\)](#)
- [Using the Pipeline State Panel \(page 78\)](#)
- [Using The Video Preview Panel \(page 79\)](#)
- [Using the Audio Preview Panel \(page 80\)](#)
- [Loading and Saving Clip List Files \(page 81\)](#)
- [Setting Up Pipeline Control Options \(page 81\)](#)
- [Using the Video Wall \(page 88\)](#)
- [Using the Label Editor \(page 91\)](#)
- [File Formats/Wrappers \(page 93\)](#)
- [Using the Diagnostics Panel \(page 92\)](#)
- [Telestream Intermediary Format \(TIFO\) \(page 104\)](#)

PIPELINE CONTROL OVERVIEW

Pipeline Control enables you to select a specific Pipeline and configure it for your workflow requirements.

Pipeline Control provides specific document types to support various digital media recording and playout tasks: Scheduled Capture (usually called a *Schedule*, for short), Log & Capture, Trigger (for manual or automated capture), Print to Tape, and Controlled Playout.

Pipeline Control allows you to open multiple documents at the same time and work with them in a tabbed window.

Figure 6–1. Typical Pipeline Control window for Windows (Schedule window shown)

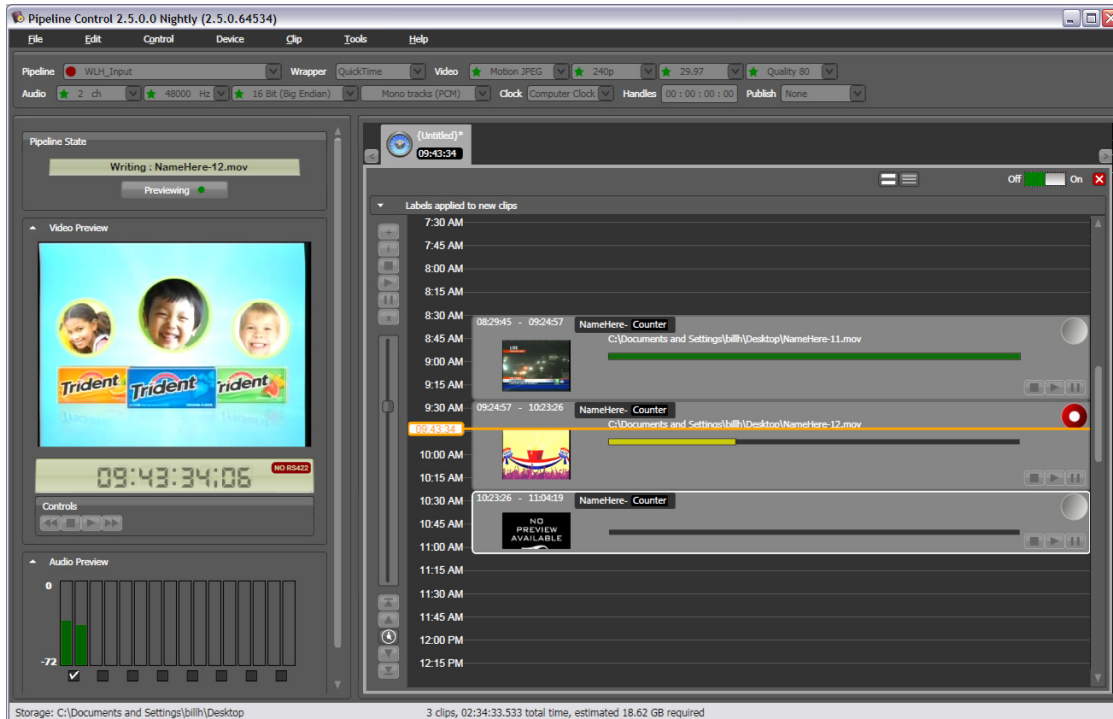

Pipelines are discovered and tracked on your network by two methods: Bonjour or manually. Bonjour is preferred on most networks, because it's automatic. You can use the manual discovery feature ([Discovery Tab on page 86](#)) to discover and select Pipelines devices across sub-nets or when Bonjour communication traffic is blocked.

Pipeline Control executes the tasks you specify in each document independently of tasks in other open documents. Tasks are executed when you activate (or turn on) a document. The panels on the left are generally the same in all document types. The panels and controls on the right are unique to each document type. Tasks specified in a document are executed when the document is activated.

Before you start working in a tab, make sure the tab is actually the one you want to update.



Note

Drag and Drop is supported in some windows. On Windows Server platforms, Windows Explorer does not run as administrator. However, Pipeline Control by default runs as administrator. When running Pipeline as administrator, files cannot be dragged from a Windows Explorer window into Pipeline Control window.

STARTING PIPELINE CONTROL

You can start Pipeline Control by selecting Start > Programs > Telestream > Pipeline > Pipeline Control.

You can also start Pipeline Control by double-clicking a Pipeline document you've saved. Or, by dropping a Pipeline document onto the Pipeline Control icon in the Programs folder or a Pipeline Control shortcut on your desktop, for example.



Note

Pipeline Control can only be used with Pipelines whose firmware is compatible.

When you install or upgrade Pipeline software, you may need to upgrade your Pipeline firmware as well. If you select a Pipeline with older firmware that is incompatible with the current version of Pipeline Control, you will be warned that this may cause problems.

When you open schedules created in previous versions of Pipeline Control, you may need to reset the audio and video settings before using them.

By default, Pipeline documents are saved in the My Documents folder. When you open Pipeline Control in this manner, the Pipeline document you double-clicked is displayed.



Note

If you're opening Pipeline Control for the first time, you should set up your Pipeline Control preferences. For details on setting up Pipeline Control preferences, see [Setting Up Pipeline Control Options \(page 81\)](#).

CREATING NEW PIPELINE CONTROL DOCUMENTS

Pipeline Control provides specific document types to support various tasks you can perform.

Creating New Documents via the Task Selector

When you start Pipeline Control (or when no documents are open), it displays a Task Selector panel that allows you to choose which task you want to perform (and thus, which type of document to display):

Figure 6–2. Use the Task Selector to create new documents.



Scheduled Capture (Page 107). Click the Scheduled Capture button to create and display a new, untitled Scheduled Capture document.

Log & Capture. (Page 117) . Click the Log & Capture button to create and display a new, untitled Log & Capture document.

Triggered Capture (Page 127). Click the Triggered Capture button to create and display a new, untitled Triggered Capture document.

Print to Tape (Page 137). Click the Print to Tape button to create and display a new, untitled Print to Tape document.

Controlled Playback (Page 145). Click Controlled Playback to create and display a new, untitled Controlled Playback document.



Note

For details on how to use the panels, controls, and features of each type of document, go to their respective chapters.

Creating New Documents via the File Menu

You can also create a new, untitled document by selecting the menu item of the appropriate window type in the File menu.

For details about how to use these documents to perform various recording tasks, see these chapters:

- Scheduled Capture – [Page 107](#)
- Log & Capture – [Page 117](#)
- Triggered Capture – [Page 127](#)
- Print to Tape – [Page 137](#)
- Controlled Playout – [Page 145](#)

PIPELINE CONTROL MENUS

Use this section as a quick reference for menu items. (General menus and menu items are not described.)

File Menu

Open. Displays an Open File dialog so you can browse and open saved Pipeline Control documents.

New Schedule Document. Displays a new, untitled Schedule Capture document.

New Log & Capture Document. Displays a new, untitled Log & Capture document.

New Trigger Document. Displays a new, untitled Triggered Capture document.

New Print to Tape Document. Displays a new, untitled Print to Tape document.

New Controlled Playout Document. Displays a new, untitled Controlled Playout document.

Import GVG 4 EDL. Displays an Open dialog so you can import a GVG 4 EDL file. ([Loading and Saving Clip List Files \(page 81\)](#)). EDLs are generated by Final Cut Pro and Avid software.

Import Final Cut Pro XML. Displays an Open dialog, so you can import a Final Cut Pro XML Interchange file. ([Loading and Saving Clip List Files \(page 81\)](#)).

Export GVG 4 EDL. Displays an File dialog so you can save the current clip list as a GVG 4 EDL file. ([Loading and Saving Clip List Files \(page 81\)](#)).

Export Final Cut Pro XML. Displays a File dialog so you can save the current clip list as a Final Cut Pro XML Interchange file. ([Loading and Saving Clip List Files \(page 81\)](#)).



Note

*When exporting one of the capture documents, the value of the **name** element (in the XML file) of a clip is determined by:*

- 1. If a clip has already been written to disk, the **name** element takes on the clip's file name without the extension.*
 - 2. If the clip has not yet been written to disk and if its title is in tokenized format, then the value of the **name** element becomes the tokenized format converted to a string. For example, if the clip's title was **Pipeline** plus the counter token, the name element used is **Pipeline COUNTER**.*
 - 3. The default name element used is **A Clip**.*
-

Exit. Closes the program. If any document has not been saved or has unsaved changes, Pipeline Control asks you if you want to save the document before closing.

Save. Saves the changes to the active window in a new document.

Save All. Saves all of the opened Pipeline documents simultaneously. Only saves documents previously saved with a name other than the default.

Save As. Displays a Save File dialog so you can save the document with a different name or in a different directory.

Save Settings as Template. Saves your current settings as default: Pipeline, wrapper, video (codec, frame size, frame rate, quality), audio (type, channels, bit depth), clock, handles, and publish. After saving your settings as a template, new documents that you create inherit these settings.



Note

Templates are stored in a file named `template.pipeline` located in:

Win7: `C:\Users\<username>\AppData\Roaming\Telestream`

To return Pipeline Control to the default document settings, delete this file.

Control Menu

Control Menu items control the state of the selected tab.

Preview. Click to connect to the selected Pipeline and display the source media, if any. You can preview video and audio whether the document is activated or deactivated. Select again to stop preview.

Active. Click to activate the document. When a document is active, it can't be edited, and it is being processed. To deactivate the document (to stop processing or to modify it), select it again.



Note

When opening Saved Schedule and Trigger documents they can be automatically activated by editing the `AutoActivate` element in the document with an XML or text editor. Simply change the `AutoActivate` element from `false` to `true`:

Document will auto activate - `<AutoActivate>true</AutoActivate>`

Device Menu and Keyboard Shortcuts

WARNING: *During capture within a Trigger session depressing the '-' or '=' key will stop the capture immediately.*

The Device menu provides commands for controlling the VTR of the connected device using the following keyboard commands and keyboard shortcuts.

Play – Space bar. Put VTR in play mode and play the video forward at normal forward speed.

Stop – K. Stop the VTR at the current play point.

Rewind – J. Play video backward at the deck's rewind speed.

Fast Forward – L. Play forward at deck's fast forward speed.

Step Backward – [(Left Brace). Step one frame backward.

Step Forward –] (Right Brace). Step one frame forward.

Go To Start (local playback only) – Control-[(Left Brace). Return the clip to the beginning.

Go To End (local playback only) – Control-] (Right Brace). Go to the end of the tape.

Clip Menu

The Clip menu commands enable you to edit or delete clips, and provide keyboard shortcuts when you are creating a new clip.

Add. Creates a new event.

Clear. Remove the selected clip (the file is not deleted from the file system.)

Edit. Edit the selected clip details and metadata.

Review. Select to review a captured clip in the Preview panel.

The following menu items are only available in Log and Capture documents:

Quick Mark – M. Single-click feature for logging a clip and setting a new mark in point. Click to set the current point on the tape as the mark out point and logs the clip. The last clip's mark out point becomes the new mark in point, so that you only have to click Quick Mark again to set the out point and log the clip.

Set Mark In – I. Set the tape's current timecode as the clip's in point.

Set Mark Out – O. Set the tapes current timecode as the clip's out point.

Go To Mark In. Roll the tape to the point specified in the Mark In timecode field.

Go To Mark Out. Roll the tape to the point specified in the Mark Out timecode field.

Log Clip – P. Create a clip under the current tape name in the tape field, using the values in the General and metadata tabs.

Tools Menu

Options. Displays the Options window, so you can configure your capture, device, update, discovery, and security settings ([Setting Up Pipeline Control Options \(page 81\)](#)).

Video Wall. Displays a panel with multiple video streams ([Using the Video Wall \(page 88\)](#)).

Label Editor. Displays an editor that allows you to create your own metadata labels ([Using the Label Editor \(page 91\)](#)).

Help Menu

User's Guide. Displays the Pipeline User's Guide (the guide you are reading).

Gather Support Information. Displays the Support Information dialog window that enables you to automatically gather information for use by technical support. The following information is gathered:

- Pipeline Trace logs
- Host system profile information
- Screen shot of the Pipeline document
- Saved document file
- Windows System and Application Event Logs
- Pipeline Device Crash log
- Pipeline F/W and Software versions
- Gather Telent 911 information

Obtain a case number from Telestream Support and enter it into the Case Number field. Click *Export To Desktop* to save information in a zip file on your desktop. Email this zip file to Telestream Support.

Figure 6–3. Support Information.

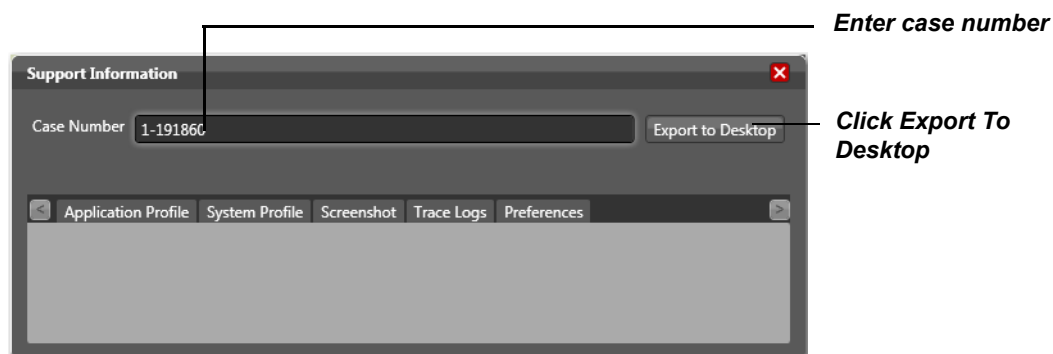

About Pipeline Control. Displays the About dialog with Pipeline Control’s version number.

USING THE PIPELINE SETTINGS PANEL

At the top of Pipeline Control is the Pipeline Settings panel. This panel displays the Pipeline settings for the active tab. There are several selectors in the panel. These selectors enable you to select a specific Pipeline and configure the document to use it specifically for the tasks or workflow you intend. Some selectors do not display in certain document types. For example, in a Trigger document, the Handles selector doesn’t display.



Note

In preview mode, these settings are disabled and you can’t make changes. To make changes, you must first return to idle mode. If Pipeline Control is has been locked ([Security Tab on page 87](#)), you also can’t make changes to Pipeline settings. Use the password to unlock Pipeline Control if you need to make changes to Pipeline settings.

Figure 6–4. Windows Pipeline Settings panel.

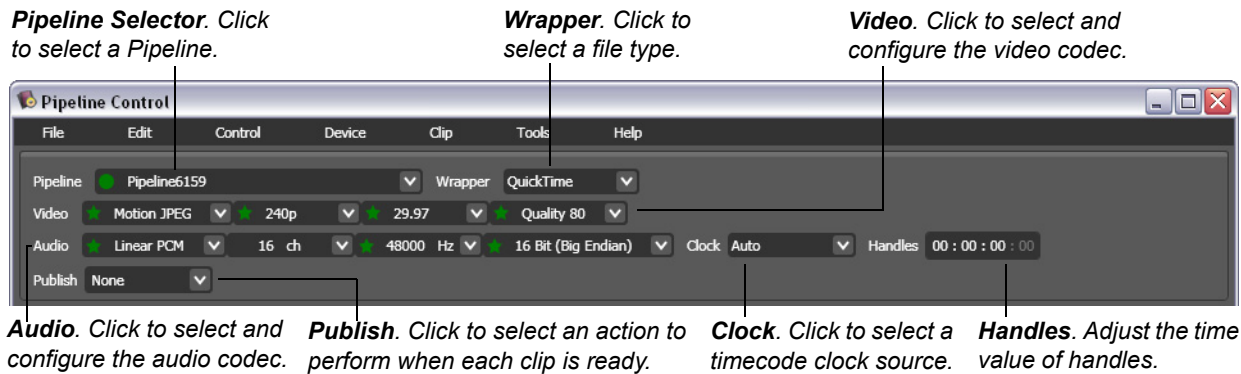

These settings are saved with the document. When the document is connected to a Pipeline, the Pipeline is configured for the task, based on these settings.

Selecting a Pipeline

To select a Pipeline, click the Pipeline drop-down list and pick one from the list. Additionally, when Pipeline Control discovers Pipelines on the network, it records the Network Interface Card (NIC) that the Pipeline responded on. The computer's routing tables are then examined to see if a valid route is available to the Pipeline Control application on which to communicate. If a valid route is not found then Update Route is displayed. Click Update Route to add a valid entry into the computer's routing table.

Figure 6–5. Windows Pipeline browser and selection window.

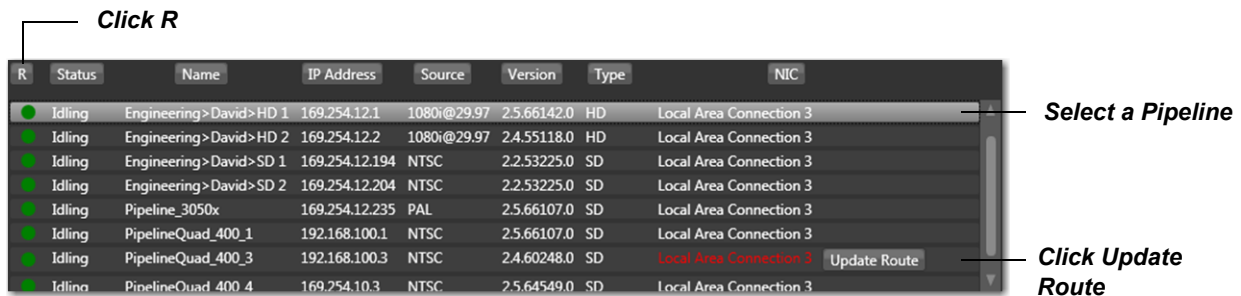

Click R to refresh status. A green bullet icon indicates that this Pipeline is available. A red bullet indicates that it is currently busy (connected to another client application). Gray indicates offline; yellow indicates an unknown state. To enable you to select a Pipeline to set up a document for use later, you can select a Pipeline regardless of its state. This dialog reports the Pipeline's current status (idle, capturing, recording, unknown), name, input source, firmware version, device type (SD or HD) and system NIC connection.

Selecting and Configuring Codecs

When you don't have a Pipeline selected (None), all codecs display. When you select a specific Pipeline, only those codecs supported by the target Pipeline are hinted with a green star icon. When choosing the frame rate, make sure you're providing an appropriate source.

Figure 6–6. Pipeline Control notifies you when your configuration is not supported by the Pipeline.

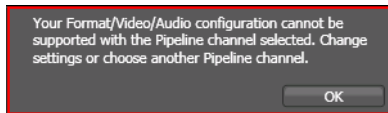

Based on your Pipeline, you can select from Motion JPEG, DV, DVCPPro, DVCPPro HD, IMX, MPEG2 I-Frame, ProRes, Avid DNxHD, and Uncompressed codecs. Each codec has one or more profiles from which you can choose.



Note

Settings are hinted when they are known to work with the selected Pipeline or wrapper and its current input signal. However, you may be creating documents for later use, when the signal is different, so you can select settings that may work if you change the Pipeline's input signal.

Hints also indicate the settings that are known to work given the selected wrapper format, such as QuickTime, TIFO, MXF OP-Atom, or MXF-OP1a. If both the selected wrapper and the selected Pipeline support the setting, it is hinted.

If you've already selected a codec and settings – and you select a Pipeline that doesn't support it – Pipeline Control will notify you when you connect that it doesn't support the selected codec.

Each codec's profile details are located in Appendix C, [Pipeline Control Codec Profiles \(page 159\)](#).

When you select a codec only the resolutions that apply to that codec are selectable. Frame Rate and Quality settings are filtered based on the resolution you select. Based on the SDI signal of the connected Pipeline, resolutions and frame rates that display a green star are compatible with the current signal.



Note

If your source is HD and you choose an SD codec, Pipeline down-converts the video according to your settings. However, Pipeline's down-convert is not intended for production use.

The SDI stream being ingested by the Pipeline may be from one of many possible sources. If you select an NTSC frame rate to encode PAL, or a PAL frame rate to encode NTSC, or other incompatible parameters, Pipeline Control displays an error and prevents the capture from occurring.

When selecting a Quality setting for NTSC or PAL captures be sure to select a setting with an Anamorphic suffix if the SDI source of the Pipeline requires anamorphic encoding. When selected, video preview is displayed at the correct aspect ratio and Pipeline Control embeds a display size flag in the QuickTime file so that other QuickTime applications can determine the correct display aspect ratio.

Selecting and Configuring a Video Codec

Click the Video drop-down menu to select the video codec you want to use. Based on your selection, the frame size, frame rate, and quality drop-down menus populate with available values. Select the frame size, rate, and quality from the drop-down menus to meet your workflow requirements.

Configuring the Audio Codec

In the Windows version, DolbyE is also available. Select the number of channels, bit rate, and sample size from the drop-down menus. Valid options display with a green star icon (hinted).

When you don't have a specific Pipeline selected (None), all Quality settings can be selected. Audio parameters include Channels (2, 4, 8, or 16), Sample Rate (always 48K) and Quality (16-bit or 24-bit, Big Endian and Little Endian).

Audio Tracks

When 2 channels are selected, audio track selection can be: *Mono tracks (PCM)* for all channels to be in individual audio tracks, or *Stereo tracks (PCM)* to pair audio channels into stereo tracks. If 4, 8, or 16 channels are selected, a third option is available which combines all channels in one track.

Each of these audio track selections (mono, stereo, and n-tracks) has an additional selection of PCM (default) or DolbyE that can be made for each channel. Select DolbyE only if you are sure DolbyE is present on the selected track.

Selecting a Timecode Clock Source

Click the Clock drop-down menu to select which device provides the timecode clock source signal. You must be connected to a Pipeline in order to obtain a timecode clock source, except when you choose Computer Clock. Choose from Auto, RS-422 Device, Sync Input (Pipeline Quad and Pipeline HD Dual), Video Input, Internal Clock, Computer Clock, Pipeline Channel 1 (when connected to a Pipeline Quad), or Zero Based timecode. When you change your timecode clock source, save your file to save changes.

Auto. When you select Auto the Pipeline system will search for the first appropriate time source in the following order: RS422, Ext Sync SDI VITC, Input Signal VITC, Zero Based.

For example, if you're connected to a Pipeline SC and RS-422 has a timecode, it will be used because it is highest priority (column on right). If not, SDI timecode will be used (2nd priority), etc.

RS-422 Device. Uses the timecode provided by the device attached to the RS-422 port on the target Pipeline; usually a VTR. If the timecode is not available, a zero-based timecode is provided.

Sync Input. For use with Pipeline Quad and HD Dual only. Uses the timecode provided through the Reference Input signal in VBI or VANC. If the timecode is not available, a zero-based timecode is provided. *Do not select Sync Input if you are connected to a single-channel Pipeline.*

Video Input. Uses the timecode provided on the Pipeline's video input signal in VBI or VANC. If the timecode is not available a zero-based timecode is provided.

Pipeline Clock. Uses the timecode provided by the Pipeline itself.

Computer Clock. Uses the timecode provided by the host computer on which Pipeline Control is running.

Pipeline Channel 1. When connected to a Pipeline Quad you can select Channel 1's timecode. This enables multiple channels of a Quad to share a common timecode when an external timecode, either on the video input or the Reference input, is not available.

Zero Based . Captures will not necessarily start at 00:00:00:00. The timecode will start at 00:00:00:00 and then free run when the document is first activated. The timecode of the capture will be whatever the timecode is when the capture is initiated.

Setting up Handles

The Handles control displays only in Log & Capture and Schedule documents. Enter the value in minutes and seconds, up to 5:59 minutes to capture before and after the actual scheduled capture time.

Selecting a Publisher

Click the Publish drop-down menu to select the system that you want to notify for each clip event. FlipFactory and Copy publishers automatically send jobs when the file is ready. For details about setting up each type of publisher, see [Configuring Publishers \(page 68\)](#).

If you don't want to directly connect to another system in your workflow to pass the saved media file and optional metadata, select None.

CONFIGURING PUBLISHERS

Publishers are methods of notifying a specific system that an event has occurred, or that media is available for processing. Methods differ, based on the notification requirements of the system you've selected. When you select a publisher, you're prompted to configure it. You can select and use one publisher per schedule.

- [Using Vantage Publish within Pipeline Control for Windows \(page 68\)](#)
- [Using Agility Publish within Pipeline Control for Windows \(page 71\)](#)
- [Side Car XML Plugin \(page 73\)](#)
- [Copy File Publisher \(page 74\)](#)
- [Avid MXF Copy File Publisher \(page 74\)](#)
- [FlipFactory Publisher \(page 75\)](#)

Using Vantage Publish within Pipeline Control for Windows

Set up and use the Vantage publisher in Pipeline Control when you want to submit media and metadata directly into an active Vantage Workflow.

Pipeline Vantage Publish can speed your jobs to near real-time by starting Vantage Workflow processes as soon as your capture begins. To do this select TIFO as the wrapper type. When capturing media into a TIFO container Vantage is notified as soon as the file is created, allowing the Workflow to begin processing media and metadata immediately, thus shortening the total processing time. When capturing media in any other file format, Vantage is notified when capture is complete and the file is closed.

There are two simple steps to configuring a Pipeline Control for use with the Vantage Publish:

1. Select the folder location where Pipeline Control will be writing the captured media file to. This is done from within the wrapper dialog (QuickTime, MXF OP1a or TIFO). The location must be accessible from the Vantage system and should be a network UNC path.
2. Select the Vantage Domain and Workflow you wish to drive from within the Vantage Publish plug-in dialog.

The workflow

Pipeline Control captures and writes a media file to a media storage location and submits a job to a selected Vantage Workflow. The job request includes the Workflow name, any metadata required by the Workflow and the location where Vantage can find the captured media file. Vantage will start the job and

processes it through the respective Workflow using the captured media file and metadata at the location given to it by Pipeline Control's Vantage Publish.

Figure 6–7. Vantage Workflow.



Creating a Vantage Workflow

You can submit a job to any active Vantage workflow. If you wish to pass metadata from Pipeline Control to a Vantage workflow then your Workflow design must begin with a Receive Action containing at least one metadata label.

Any metadata label contained in the Receive Action will be pushed forward to the Pipeline Control's Label interface allowing the user to enter the appropriate data.

Figure 6–8. Vantage Design Workflow.

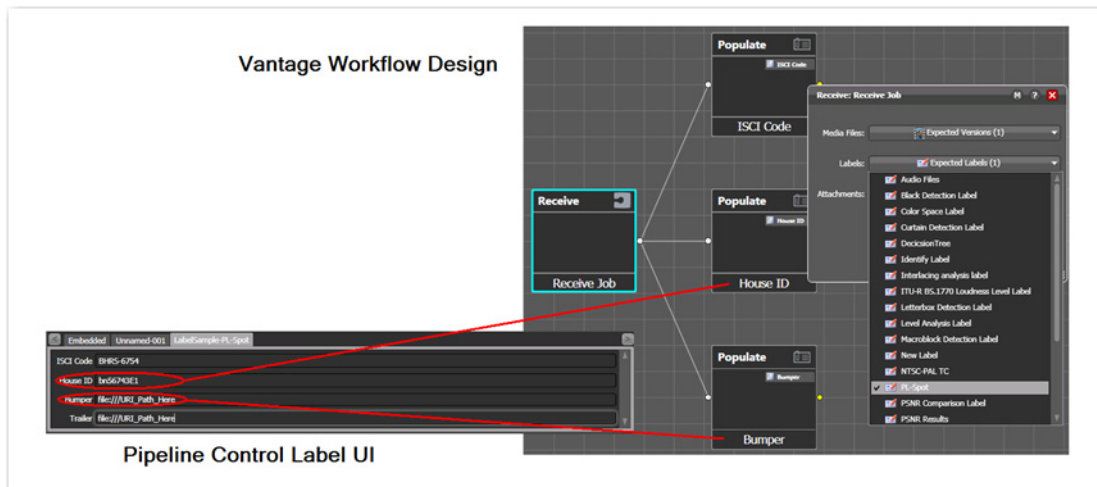

Selecting the Pipeline Control storage location

Create and configure the Pipeline Control document (Schedule, Log&Capture or Trigger) you plan to use for this workflow, including the wrapper and media format, and the storage location you plan to use. In the Wrapper dialog, specify the storage location (see Selecting a Wrapper section in Chapter 8 of the Pipeline User Guide) on a network share, or a share directly on the Vantage server (recommended specifically for TIFO files, processed in real time). This storage location will be referenced by the Vantage Publish as described below.

Setting up Vantage Publish

Follow these steps to configure Pipeline Control's Vantage Publish:

1. Open the appropriate Pipeline Control document.
2. Select Vantage as a publisher by selecting Publish > Vantage.
3. From the Vantage Publish setup dialog enter the target Vantage serve name or IP address. The Port number defaults to 8676 and should be changed only if this has been modified when your Vantage server was installed.
4. Press the Connect button to display all of the Workflows on your Vantage system.
5. Select a Workflow from the list that appears. Note that the Workflow list indicates the current Status of the Workflow (Active, Editing or Idle) and number of Labels that are available to Pipeline. If the workflow's Status is Idle it can be activated by selecting the Activate button under the workflow selection panel. Workflows with a Status of Editing cannot be used until they are in the Idle or Active status mode.
6. Select OK to close the Vantage Publish dialog.
7. If you have not already done so configure all other Pipeline Control parameters. Pay particular attention when selecting the location where Pipeline Control will be writing the media file. Make sure that the location where Pipeline Control is writing the file is equivalent to the location where Vantage will be looking for it.

Figure 6–9. Vantage Publish Setup

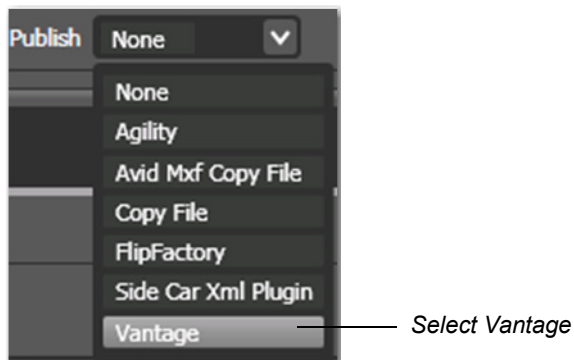

8. In the Vantage window, enter the host machine name, the port address, and click Connect. Select a Vantage workflow, and (optionally) browse to a file location. If no location is defined, the file location defined in the *Wrapper* menu is used (hover over *Wrapper Settings* to see a visual of this menu).

Figure 6–10. Vantage Window

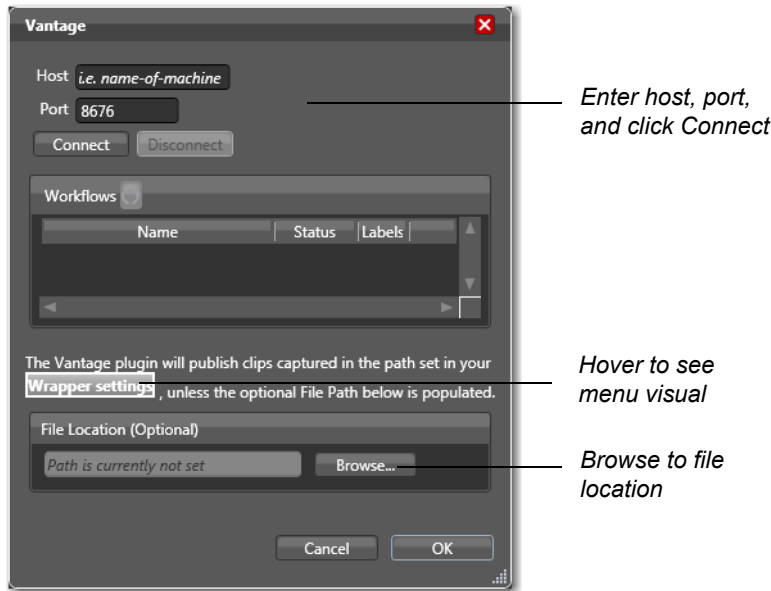

Vantage Metadata Labels

If there were any metadata labels as part of the Workflow they will appear in the Pipeline Control Label UI. Their names will be [**<Vantage Workflow name> - <Label name>**].

Figure 6–11. Vantage Metadata Labels

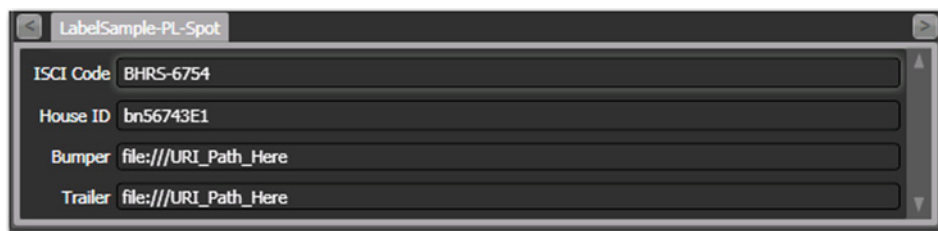

Using Agility Publish within Pipeline Control for Windows

Set up and use the Agility publisher in Pipeline Control when you want to submit media directly into an Agility Job Profile.

There are two simple steps to configuring a Pipeline Control for use with the Agility Publish:

1. Select the folder location where Pipeline Control will be writing the captured media file to. This is done from within the wrapper dialog (QuickTime or MXF OP1a). The location must be accessible from the Agility system as a network UNC path.
2. Select the Agility Node and Job Profile from within the Agility Publish plug-in dialog.

The workflow

Pipeline Control captures and writes a media file to a media storage location and submits a job to a selected Agility Job Profile. The job request includes the Job Profile name and the location where Agility

can find the captured media file. Agility will start the job and processes it through the respective Profile using the captured media file at the location given to it by Pipeline Control's Agility Publish.

Figure 6–12. Agility Workflow.



Selecting the Pipeline Control storage location

Create and configure the Pipeline Control document (Schedule, Log&Capture or Trigger) you plan to use for this job, including the wrapper and media format, and the storage location you plan to use. In the Wrapper dialog, specify the storage location (see Selecting a Wrapper section in Chapter 8 of the Pipeline User Guide on a network share, or a share directly on the Agility server (recommended). This storage location will be referenced by the Agility Publish as described below.

Setting up Agility Publish

Follow these steps to configure Pipeline Control's Agility Publish:

1. Open the appropriate Pipeline Control document.
2. Select Agility as a publisher by selecting Publish > Agility.
3. From the Agility Publish setup dialog enter the target Agility serve name or IP address. The Port number defaults to 80 and should be changed only if this has been modified when your Agility server was installed.
4. Press the Connect button to display all of the Job Profiles on your Agility system.
5. Select a Job Profile from the list that appears.
6. Now you must select the location where Agility can find the captured media file that Pipeline Control will create. The File Location field needs to be entered from the perspective of the Agility Server and must be the same location that was entered in the Wrapper dialog. Complete the File Location field by following the instructions below based on where Pipeline Control will be writing the media file.
7. Select OK to close the Agility Publish dialog.
8. If you have not already done so configure all other Pipeline Control parameters. Pay particular attention when selecting the location where Pipeline Control will be writing the media file. Make sure that the location where Pipeline Control is writing the file is equivalent to the location where Agility will be looking for it.

Figure 6–13. Agility Publish Setup

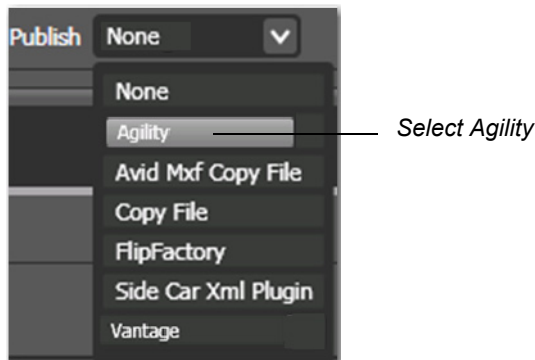

9. In the Agility window, enter the host machine name, the port address, and click Connect. Select a profile space and a job profile, and (optionally) browse to a file location. If no location is defined, the file location defined in the *Wrapper* menu is used (hover over *Wrapper Settings* to see a visual of this menu).

Figure 6–14. Agility Window

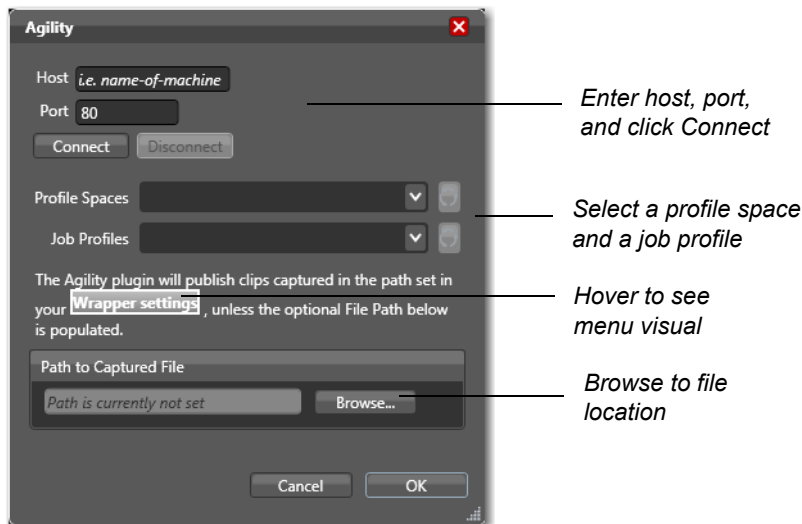

Note

If you make a call to retrieve the list of profile spaces (at `http://<some_url>/AgilityRest/profilespaces`), the user defined space is always returned even if the Use System Default option in the Web UI is checked.

Side Car XML Plugin

The Side Car XML publishing plugin will take any populated metadata label, create a XML file, and deliver it to a specified location. The file can be delivered upon file creation or when the file is completely captured.

Figure 6–15. Side Car XML allows publishing of metadata labels.

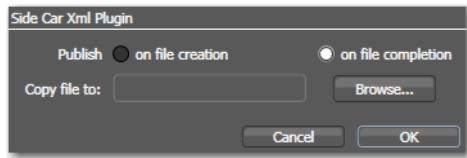

Use the Side Car XML plugin for workflows that require XML metadata in conjunction with a media file. Custom metadata labels can be created by using the Pipeline Control's Label Editor.

Copy File Publisher

The Copy File publisher is used to copy a captured clip to another local folder or network share. To select Copy File as a publisher, select Publish > Copy File. The following edit panel displays.

Figure 6–16. Copy File publisher allows you to duplicate just-completed clips.

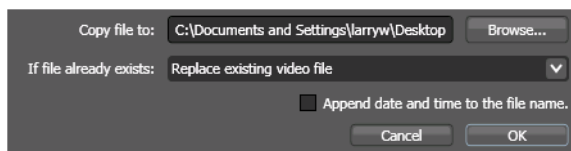

Complete the panel and click OK. Save the document to save these settings. Make sure you test your configuration before putting the document into production.

Copy File To. Click to display the File System dialog, and select the folder where you want to copy the file.

If File Already Exists. Select the action to take if there is already a file of the same name in this folder: Replace the existing file, save the new file with a unique name, or don't copy the new file.

Append date and time to file name. The date and time is appended, in the format *YYYY-MM-DD HH-MM-SS*. For example, if the file *Pipeline10.MOV* was created on December 5, 2008 at 13:15 when copied, it would be named *Pipeline10 2008-12-05 13-15-00.MOV*.

Avid MXF Copy File Publisher

The Avid MXF Copy File publisher is used to copy a captured clip to another local folder or network share. To select this as a publisher, select Publish > Avid MXF Copy File. The following edit panel displays.

Figure 6–17. Avid MXF Copy File publisher allows you to duplicate just-completed clips.

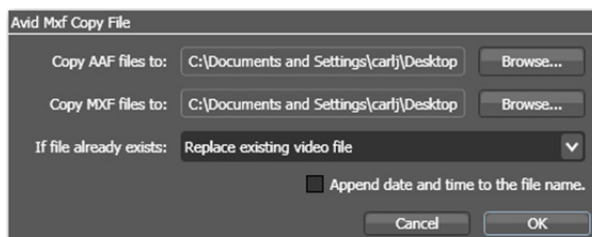

Complete the panel and click OK. Save the document to save these settings. Make sure you test your configuration before putting the document into production.

Copy AAF Files To. Click to display the File System dialog, and select the folder where you want to copy the AAF files.

Copy MXF Files To. Click to display the File System dialog, and select the folder where you want to copy the MXF files.

If File Already Exists. Select the action to take if there is already a file of the same name in this folder: Replace the existing file, save the new file with a unique name, or don't copy the new file.

Append date and time to file name. The date and time is appended, in the format YYYY-MM-DD HH-MM-SS. For example, if the file *Pipeline10.MOV* was created on December 5, 2008 at 13:15 when copied, it would be named *Pipeline10 2008-12-05 13-15-00.MOV*.

FlipFactory Publisher

Set up and use the FlipFactory publisher in Pipeline Control when you want to implement Pipeline Control > FlipFactory workflows that automatically submit media to a factory for processing. Optionally, you can implement submit metadata on a per-job basis.



Note

Telestream recommends installing Pipeline Control on a computer that is not hosting FlipFactory or other media processing applications: intense disk and CPU consumption can interfere with proper operation of both applications.

FlipFactory publisher requires FlipFactory version 6.0 (with update packs 1-4 installed), or greater. (See FlipFactory support Web page at www.telestream.net for updates.)

When submitting jobs with TIFO files, it is important to save the file directly on the FlipFactory or Episode Engine server for efficient processing by FlipFactory or Episode.

Refer to [General Pipeline System Setup Information \(page 27\)](#) when writing media files to a shared storage location.

Factories used by FlipFactory publishers should not have a monitor enabled. The FlipFactory publisher submits job messages directly to the Flip Engine server, eliminating the requirement for a monitor. Alternatively, you can configure a factory with a monitor that monitors the storage location specified in your wrapper format, and *do not* implement a FlipFactory publisher in your Pipeline Control document.

The FlipFactory publisher can integrate with the factory you've specified in Pipeline Control using any file format and wrapper (except for Avid AAF+MXF) you need for your workflow requirements. To speed your workflow to near real-time by starting transcoding as soon as capture starts, select TIFO as the file type.

Using TIFO files, FlipFactory is notified as soon as the file is created and transcoding occurs as soon as it is available, thus shortening total processing time. When capturing media in QuickTime files or other wrappers, FlipFactory is notified when the operation is complete and the file is closed.

Design your Pipeline Control > FlipFactory Workflow

Set up your FlipFactory Factory. Configure a factory to produce the media and optionally process metadata per your workflow requirements. Do not enable a monitor – the FlipFactory publisher submits jobs automatically.

Set up your Pipeline Control Document. Create and configure a Pipeline Control document for this workflow, including the wrapper and media format, and the storage location for captured clip files. In the Wrapper dialog, specify the storage location: local on your Pipeline Control host system, on a network share, or a share directly on the FlipFactory server (recommended specifically for TIFO files, processed in real time).

Enable and configure the FlipFactory publisher to automatically submit media files you've captured in your document to a specific location, and a specific FlipFactory factory for processing.

The FlipFactory publisher implements automatic file integration by instructing your factory to ingest media from the server (local, network share, or FlipFactory) where you have configured the Pipeline Control document to write clip files, using the Wrapper dialog.

To select FlipFactory as a publisher, select Publish > FlipFactory. The following panel displays:

Figure 6–18. FlipFactory publisher panel allows you to submit media to a specific factory.

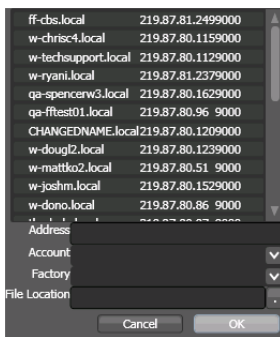

FlipFactory Server. Select the target FlipFactory from the list.

Address. Displays the selected FlipFactory server; allows you to enter it manually – enter its IP address or server name and port number in the form <IP address|ServerName>.local:<Port Number (default 9000)>.

If you're submitting jobs to a FactoryArray, enter the FactoryArray's virtual IP Address in the Address field. After selecting or entering the FlipFactory server's ID, the FlipFactory Publisher will connect to the FlipFactory database to obtain the accounts and associated factories and display them.

Account. Select the account on the selected FlipFactory from the popup menu. When you select an account, Pipeline Control queries FlipFactory for a list of factories in the account, and takes a few seconds.

Select the factory from the list of factories in the selected account. If this factory has metadata labels, they will be displayed so that you can provide metadata values to submit to the factory.

File Location. When selecting a directory from the File location list, note that the path is formed from the perspective of the FlipFactory server.



Note

The servers, drives, and folders are local to the FlipFactory server. Only select a local drive/folder when Pipeline Control is configured in the Wrapper to write clip files directly to a FlipFactory server share.

All metadata labels associated with the selected account are displayed in Pipeline Control for data entry.

If the Pipeline Control wrapper Location has been configured to write files to a shared network folder (either directly on the Pipeline Control host system or other network file server), manually enter a path to

the file in UNC format. If the Pipeline Control wrapper Location has been configured to write files to a shared network folder directly on the FlipFactory server, click Browse to navigate and select the local directory in drive-letter format.

Figure 6–19. Pipeline Control – FlipFactory file sharing options.

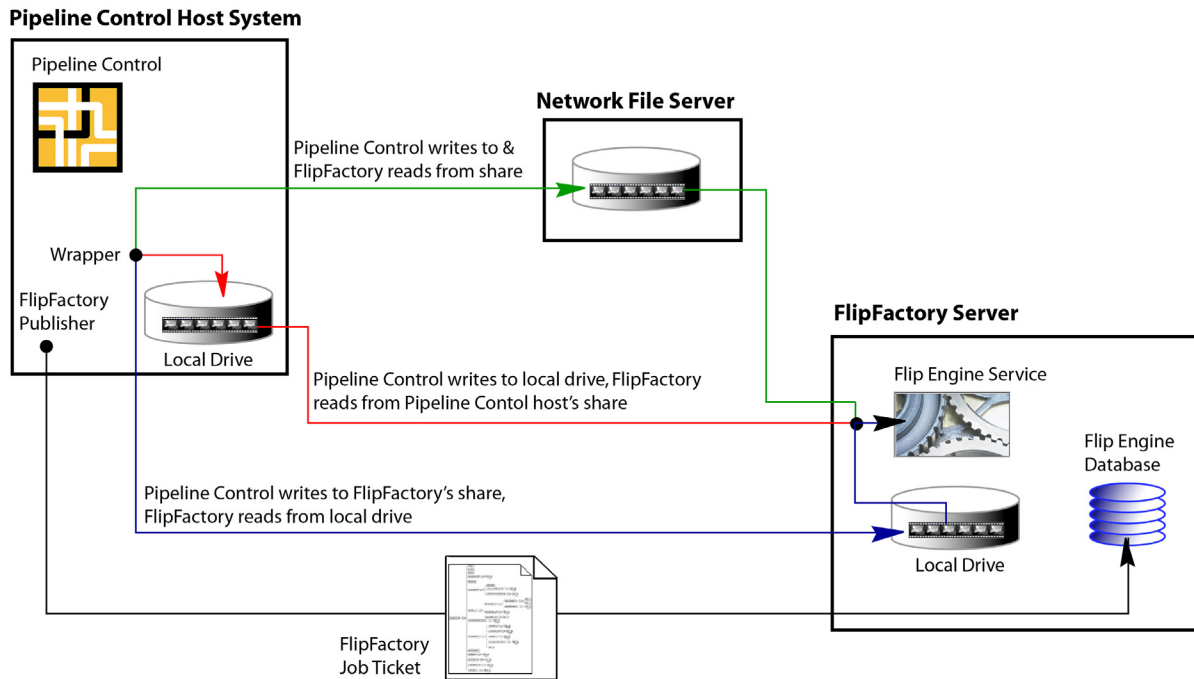

Use this table to determine how to specify the Pipeline Control file read and write directory in Pipeline Controls' Wrapper dialog and FlipFactory publisher dialog:

Table 6–1. Configuring clip file paths for Pipeline Control and FlipFactory access.

Pipeline Control File Write Directory	FlipFactory File Read Directory
<p>Pipeline Control Local Directory. In the Wrapper dialog, browse and select a letter-drive directory on this computer. The directory must be configured as a share for FlipFactory and the user name Flip Engine service operates under must have Read permission. Syntax: <Drive>\<directory>\... Example: C:\PipelineControl\ScheduleClips</p>	<p>Pipeline Control Local Directory. In the FlipFactory Publisher dialog, browse and select the share on the Pipeline Control host system. Syntax: \\<PipelineControl Host>\<ShareName> Example: \\PipelineControl\ScheduleClips</p>
<p>Network Share. In the Wrapper dialog, browse and select the share on the network file server. The user names Pipeline Control operates under must have Full Control permission and Flip Engine service operates under must have Read permission. Syntax: \\<Network File Server>\<ShareName> Example: \\NetServer007\ScheduleClips</p>	<p>Network Share. In the FlipFactory Publisher dialog, browse and select the same Share on the target network file server. Syntax: \\<Network File Server>\<ShareName> Example: \\NetServer007\ScheduleClips</p>
<p>FlipFactory Server Local Directory. In the Wrapper dialog, browse and select a Share on the FlipFactory server. Syntax: \\<FlipFactory Server>\<ShareName> Example: \\FlipFactory001\ScheduleClips</p>	<p>FlipFactory Server Local Directory. In the FlipFactory Publisher dialog, browse to select the directory directly on the FlipFactory server. The directory must be set up as a share for Pipeline Control and the user name Pipeline Control operates under must have Full Control permissions. Syntax: <Drive>\<directory>\... Example: C:\FFStores\ScheduleClips</p>

Configure the settings in the panel and click OK. Make sure you test before putting the document into production.

USING THE PIPELINE STATE PANEL

The topmost panel on the left side of Pipeline Control is the Pipeline State panel. Use the Pipeline State panel to determine the current state of the Pipeline you’re connected to. The Pipeline State panel cannot be closed – it remains open and active at all times.

Figure 6–20. The status window displays current Pipeline activity.

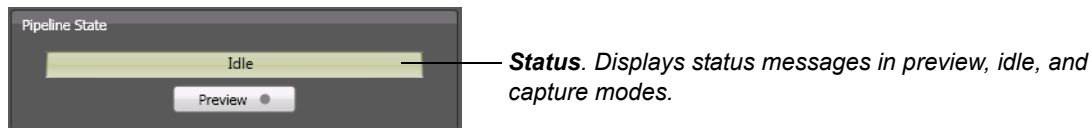

The Pipeline State panel displays the current Pipeline activity: idle, closing connection, establishing a connection, previewing, capturing, preparing, playing out, etc. The status bar pulses red when writing a file to disk.

USING THE VIDEO PREVIEW PANEL

The Video Preview panel displays video during preview, capture, and playout operations with the current timecode in HH:MM:SS:FF format. VTR controls are directly below.

To open or close the Video Preview panel, click the expand/collapse arrow (top left corner of the panel).

Disable preview by closing the panel to decrease CPU load during capture.

You can also play local clip files (clips that have already been captured) in the document. Hover over the clip and select Play.

Figure 6–21. Use the Video Preview panel to view the incoming video stream.



When video is being encoded and streamed from the Pipeline, you can preview the media.

Deck Controls



Note

These controls are only enabled when the Pipeline channel is connected to a device via RS-422 and that device is in Remote mode. They are also enabled when reviewing a captured clip. However they control the playback of the local clip and not a deck.

Use the VTR controls to preview video from the deck, connected via RS-422. The exact performance depends on the implementation of the commands on the deck itself. For example, Fast Forward on one deck may advance the tape at a different speed than Fast Forward on another deck.

Figure 6–22. Use VTR controls to preview video from your attached deck or to control playback of captured clips.

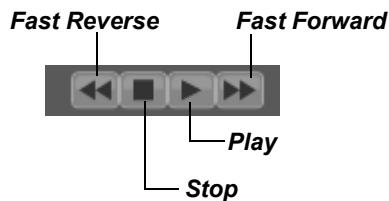

Note

When playing back captured clips a pause button is also displayed.

Fast Reverse. Click to roll tape backward.

Stop. Click to stop the deck.

Play. Click to play video at normal forward speed.

Fast Forward. Click to roll tape forward.

Jog/Shuttle Wheel

Jog. Click and hold the mouse button as you move the mouse in a circular motion to roll the tape forward or reverse, frame by frame.

Shuttle. Advance or Rewind the tape using the Shuttle mode. Range +3.0 to -3.0.

Cue. Enter a time code to cue the deck.

The current time code can be marked using the button:



Go. Click Go, to cue the deck.

USING THE AUDIO PREVIEW PANEL

Use the Audio Preview panel when playing video to see the decibel output of up to 16 channels of audio.

To open or close the Audio Preview panel, click the expand/collapse arrow at the top left corner of the panel.

Figure 6–23. The Audio Preview panel displays decibels in real time for each audio channel.

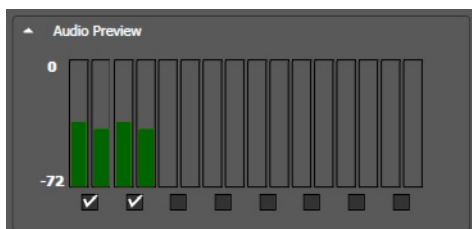

The scale of the meter is -72 dBFS to 0S dBFS.

Disable preview by closing the panel to decrease CPU load during capture.

LOADING AND SAVING CLIP LIST FILES

In all capture documents, Pipeline Control enables you to load the clip list from an EDL or a Final Cut Pro XML Interchange file. You can also save a clip list you've made, in XML and EDL formats. Loading and saving clip lists via files promotes interchange between applications and systems, without manually re-creating them. These interchange files can be used for time-shifting your work, to avoid performing the same actions multiple times, or to participate in workflow tasks with others.

For example, one person can define a list of clips, save the list as an XML file, and then pass the file on to someone else on the network who performs the actual capture.

To load a clip list, use one of the following menu items:

File > Import GVG 4 EDL. Select to populate the clip list with entries from a Pipeline EDL file (or other GVG 4 compatible files such as those found in Final Cut Pro or Avid Media Composer). Make sure your Pipeline configurations are set prior to importing your EDL.

File > Export GVG 4 EDL. Select to save a clip list with entries to a Pipeline EDL file (or other GVG 4 compatible files such as those found in Final Cut Pro or Avid Media Composer).

File > Import Final Cut Pro XML. Select to populate the clip list with entries from an EDL file in Final Cut Pro XML Interchange Format.

Pipeline Control displays an open dialog. Navigate to the location where the file you want to open is stored, select it, and click Open to load the clip list.

You can also save clip list entries as a file in GVG 4 EDL or Final Cut Pro XML Interchange Format.

File > Export Final Cut Pro XML. Select to save the clip list in Final Cut Pro XML Interchange Format.

Pipeline Control displays a Save dialog. Enter the name of the file to save, and select the location where you want to save the file. Click Save to save the clip list in XML Interchange Format.

XML Interchange Format can be generated from Final Cut Pro, or any other application that supports this format. XML Interchange Format is the file format that Pipeline import/export or capture/playout documents load from and save in, in order to promote interoperability with other applications. Clip list files can also be generated and edited manually.

For further details, refer to Apple's documentation on XML Interchange Format:

http://developer.apple.com/documentation/AppleApplications/Reference/FinalCutPro_XML/AboutThisDoc/chapter_1_section_1.html

SETTING UP PIPELINE CONTROL OPTIONS

Select Tools > Options to set up Pipeline Control the way you want to use it.

Capture Tab

Figure 6–24. Capture Options

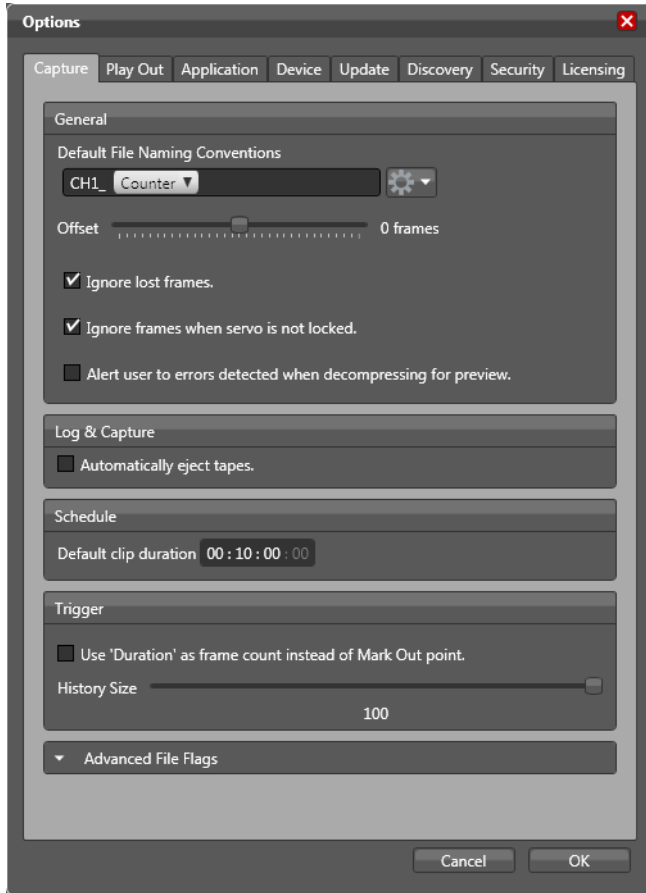

Default File Naming Conventions. Enter a phrase to use as the base name for new video files and any token types. Token types can be Date, Time, Mark In (inclusive First Frame TC), Mark Out (exclusive Last Frame TC), Counter (increments by 1), Pipeline (name), Tape (name), Codec, Frame Rate, and External. Only the counter token ensures unique names.



Note

Naming Tokens are applied when a clip is added to the clip list. The tokens Mark-In, Mark-Out, Date and Time are applied to the name based on the values known at the time they were added. If the start or end times are modified (through CalDav or the Web Service API), the new start and end values will not be reflected in the clip's name at the time of capture.

Offset. Set the offset size (number of frames): minimum is -16 frames, maximum is +16 frames, default is 0 frames. Since frames can occur early or late, depending on the deck used, this adjustment offsets the capture based on the number of frames chosen and then compensates for decks that are not 100% frame

accurate (or for systems with routing latency compared to the timecode). This adjustment must be made by a process of trial and error.



Note

The frame offset is only applied when a connection with Pipeline is established. To apply a new frame offset setting, disconnect, then re-connect with Pipeline.

Ignore Lost Frames. When checked, a capture session continues even if frames have been lost. If unchecked, the capture session aborts when any lost frames occur.

Ignore frames when servo is not locked. When checked, frames are ignored when the servo is not locked.

Alert User to Errors. Check to cause a warning message to display if any frame compression errors are detected when decompressing the video for preview.

Automatically Eject Tapes. When checked, Pipeline Control ejects the tape when capture is complete. The VTR must be in remote mode and connected to the Pipeline via RS-422.

Default Clip Duration. Sets the schedule's default clip duration when they are added to the schedule using the plus (+) button.

Use Duration as frame count. This option applies to files captured by the Trigger document. It is used when you want the captured file to contain a certain amount of frames that add up to the duration entered into the Duration field. If you know that there will be time code jumps in the incoming media stream, using this option will allow your file to have a total duration that includes the time code jumps.



Note

Capturing with this option enabled will result in files that contain a frame count that equals the duration entered into the Duration field. Scheduled events or other captured events may continue beyond the original time code represented by the OUT time code. Do not use this option if a specific OUT time code is to be used as the stop point. Additionally, calendar trigger captures will fail to update if the calendar event is edited, and the end parameter will not work for Web service captures.

Trigger History Size. Use slider bar to limit the number of events that are stored in trigger history from 1 to 100. Default is 100 events.

Advanced File Flags. Select Write Through to provide caching only when reading from the disk. Select None to use caching for disk reading *and* writing. Select No Buffering to eliminate all read and write caching. The default is *None*.



Note

These options control the flag sent to the native operating system where the Pipeline files will be written. They should only be used by advance users who have a full understanding of their system and what is required for efficient file writing

Application Tab

Figure 6–25. Application Options

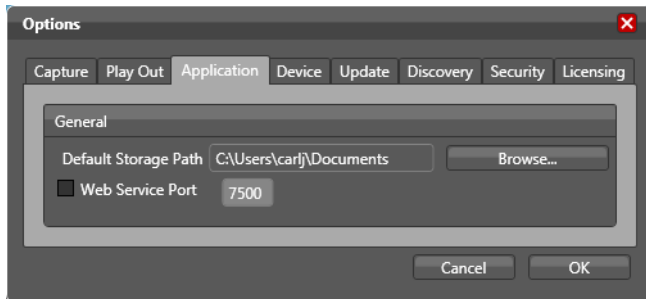

Default Storage Path. Specifies the default storage path for any container when it is opened. To set, click Browse and navigate to the desired storage location.

Web Service Port. The Web Service Port is the TCP port used to communicate to the Master Web API. This API allows automated control of the Pipeline Control applications. It also enables the user to add or remove Pipeline documents, to activate or deactivate documents, and to get document status. The full API command documentation can be listed by entering the URL *http://localhost:[port number]* into a browser on the Pipeline Control computer.

Device Tab

Figure 6–26. Device Options

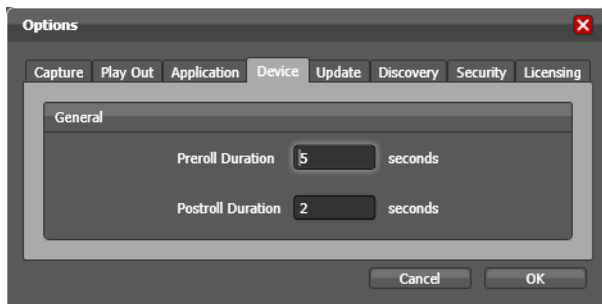

Preroll Duration. Specify the seconds to preroll video from start timecode during import operations.

Postroll Duration. Specify the seconds to postroll video from end timecode during import operations.



Note

The above settings affect log and capture for capture operations, and insert and assemble for playout operations.

Play Out Tab

Figure 6–27. Play Out Options

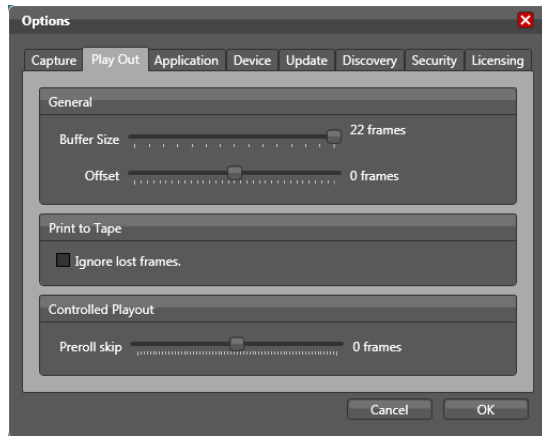

Buffer Size. Set the buffer size (number of frames) -- minimum 8 frames, maximum 22 frames. The default is set at 22 frames to provide maximum reliability.

During playout, the Pipeline queues frames in memory to compensate for network latencies. If the buffer size is set for a large number, it can 'ride out' higher transient latencies. However, a large number also introduces a longer delay between the time the frame is emitted on the network and the time that the frame appears on the SDI connection (about 1/4 second for 8 frames, up to about 3/4 second for 22 frames).

If you are concerned with latency between the time video is exported from the computer and the time it is sent out the Pipeline, you should adjust the value lower. However, lowering this value makes the connection more susceptible to errors due to insufficient CPU power or network bandwidth.

Offset. Set the offset size (number of frames). The minimum is -16 frames and the maximum is +16 frames. The default is 0 frames.

Frames can occur early or late depending on the deck used. This adjustment offsets the playout based on the number of frames chosen and compensates for decks that are not 100% frame accurate to the timecode provided. This adjustment is made by a process of trial and error.



Note

Only applicable when time base is RS422.

Ignore lost frames. Check this option to force Pipeline to ignore all lost frames. When unchecked (normal mode) Pipeline halts and alerts the user when a frame is lost.

Preroll Skip. Preroll skip is used when the Controlled Playout document is controlled through RS422 and is commanded to preroll back to a timecode prior to the first frame of the clip. This setting should be set to a value greater or equal to the value set for Buffer Size in the *General* section above. Adjust this setting if needed to insure frame accurate RS422 playout.

Update Tab

Figure 6–28. Update Options

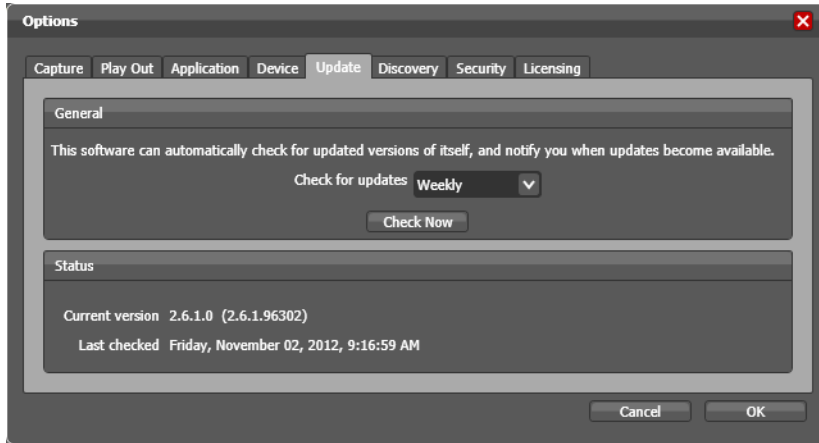

The Update panel enables you to determine which version of Pipeline Control is installed, when it was last checked, and when to check for updates from the Telestream Web site.

Check for Updates. Select Daily, Weekly, Monthly, or Never, to check for application updates.

Check Now. Click Check Now to check Telestream’s Web site for application updates right now, and let you know if Pipeline is up to date or updates are available.

Discovery Tab

Figure 6–29. Discovery Options

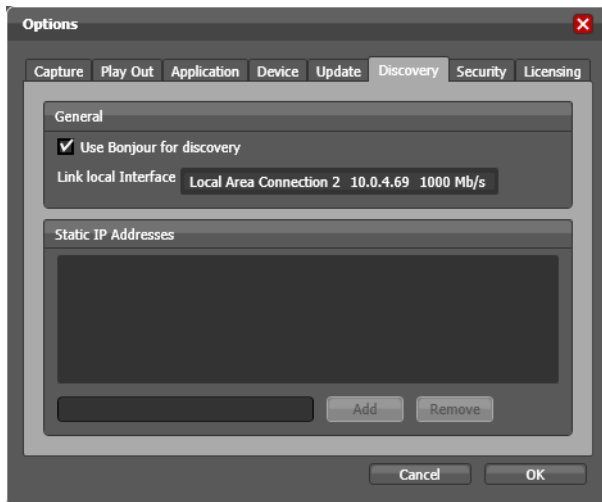

Use Bonjour for Discovery. Check when you want to automatically discover a list of Pipelines, which you can view when you browse, by clicking the Pipeline drop-down list in the Pipeline panel.

Link Local Interface. In most circumstances, auto discovery utilizes the correct link local interface from the NIC card on your computer. If you have more than one NIC card or active interface, you may have to

select the correct interface. Auto discovery does not operate over routers and gateways, so this feature does not enable you to access Pipelines beyond the link local interface – over a VPN, for example.

Static IP Addresses. If you have Pipelines that you must access and they are not accessible via auto discovery, you can add them manually. To add a new Pipeline to the Pipeline drop-down list, enter the IP address of the Pipeline in the text field at the bottom left, then click Add. To remove a Pipeline from the list, select it and click Remove. Click OK to update the list and close the Options window.

When you click the Pipeline drop-down list in the Pipeline panel, it will display the Pipelines you added manually. Capture performance may be poor when connecting to Pipelines via routers and gateways.

Security Tab

Figure 6–30. Security Options

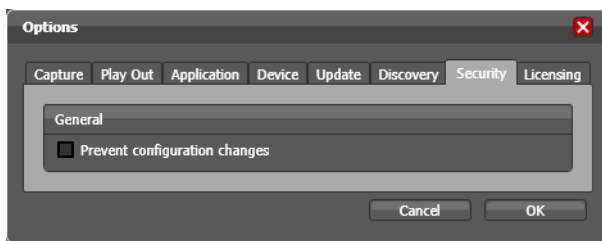

Prevent Configuration Changes. Check to prevent users from altering Pipeline settings without knowing the password. Pipeline Control prompts for a password. When you open a document, you can use it and make changes to the document itself, but you can't change Pipeline settings. To turn this security feature off, uncheck Prevent Configuration Settings, supply the appropriate password, and click OK.

Licensing Tab

Figure 6–31. Licensing Options

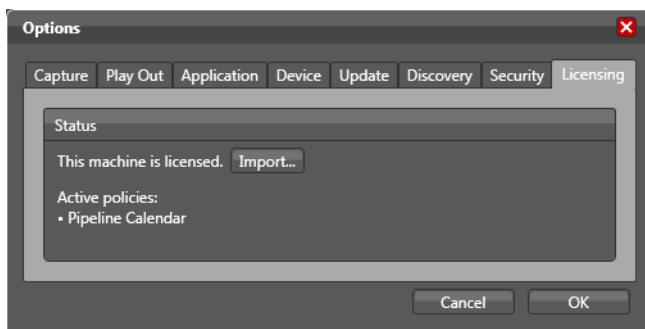

If a Pipeline feature requires a licence, it can be obtained by contacting Telestream, who will need the MAC address of the computer running the Pipeline Control software. Once you obtain the license file, click *Import* to navigate to the location of the license file on your computer, then select it and click *Open*.

After you install a license you will see the message *This machine is licensed* displayed in the Licensing tab window.



Note

The Calendar control requires a license. Without a license, the Calendar checkbox is greyed out and the message **Calendar Trigger is not Licensed** is displayed in red.

USING THE VIDEO WALL

Select Tools > Video Wall to display the Video Wall. The Video Wall enables you to view multiple video sources in one panel and display any channel configured as part of Pipeline Control. Each display provides: channel name, status, time code, and audio meters.

To add a new video source to the Video Wall, save the document with a unique name then click and drag the Video Preview panel onto the Video Wall, or right-click and select *Add to Video Wall*. The new source is displayed in the upper left hand corner. Additional sources can be added in the same way or by clicking in the Open icon at the top of the Video Wall and navigating to the location of the desired source.

When all document displays have been added you can rearrange them by selecting and dragging them to a new location. Click the Save icon at the top to save the Video Wall settings. The *Activate All* switch activates all video clips displayed on the wall. *Auto Activate*, when checked, causes saved video clips to activate when Video Wall is re-opened. The slider resizes all video clips in the video wall. They cannot be resized individually.

Figure 6–32. Video Wall Display

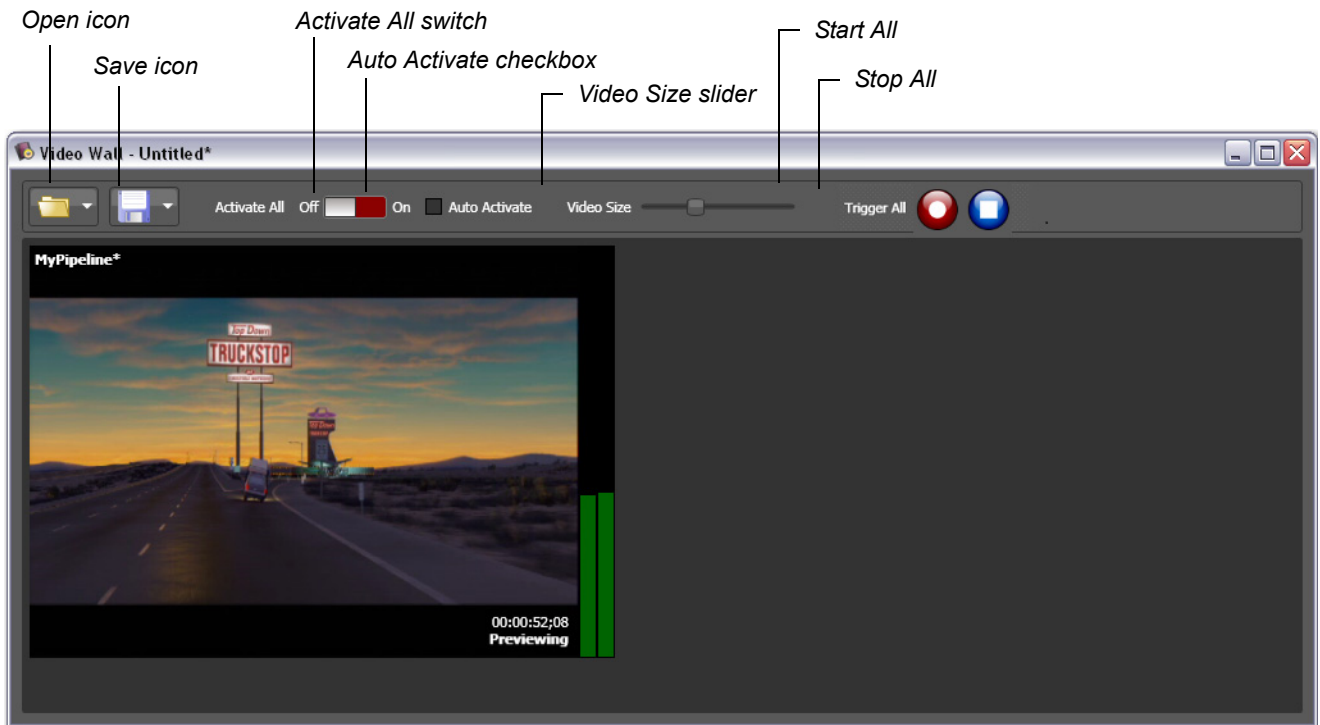

All Preview displays are framed in a color border. The border color indicates it's current state: a Yellow border indicates a waiting state, green indicates the playout state, red indicates the capturing state, and white indicates the previewing state. No border indicates an idle state.

Figure 6–33. Video Wall Display Borders



If capturing into a TIFO container and a MARK-Out Web API command has been issued (see *Pipeline Web Service API Reference* for Mark-IN/Out description) OUT will be displayed in the upper right hand corner of the channel's display. The OUT overlay is cleared when a MARK-In command is issued or when the capture is complete or stops.

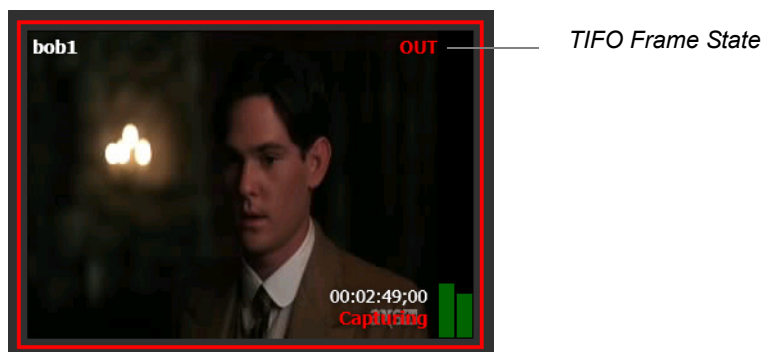

Selecting a preview display will automatically highlight the associated channel tab on the Main application window.

Figure 6–34. Associated Channel Tab Activation

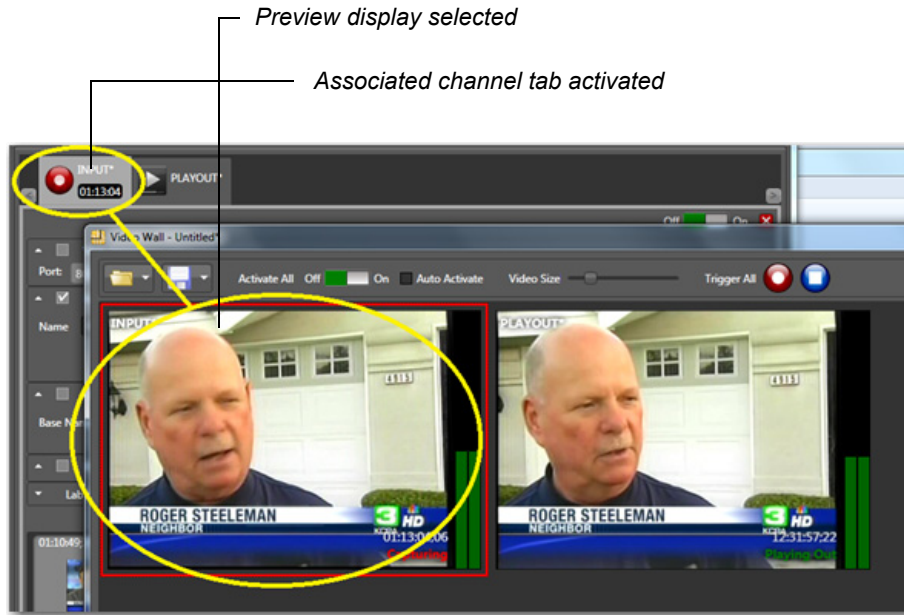

Each display on the video wall has a right click menu containing: Activate/Deactivate video, Start/Stop Capture, and Properties:

Figure 6–35. Right-click Menu

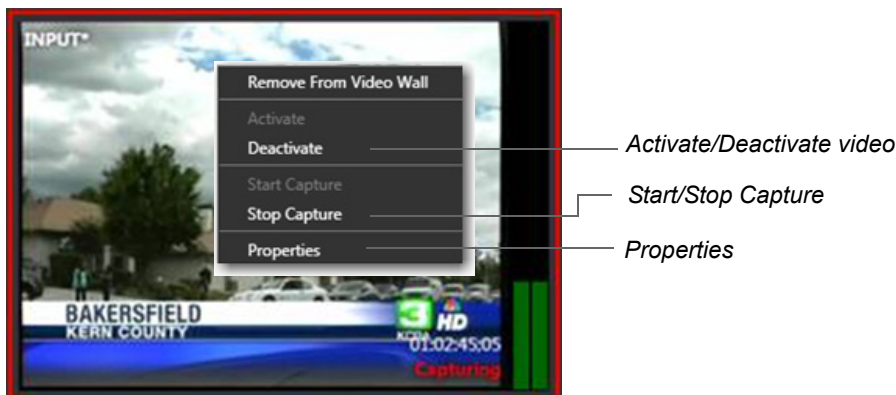

When Properties is selected, a properties window is displayed:

Figure 6–36. Properties Window Menu

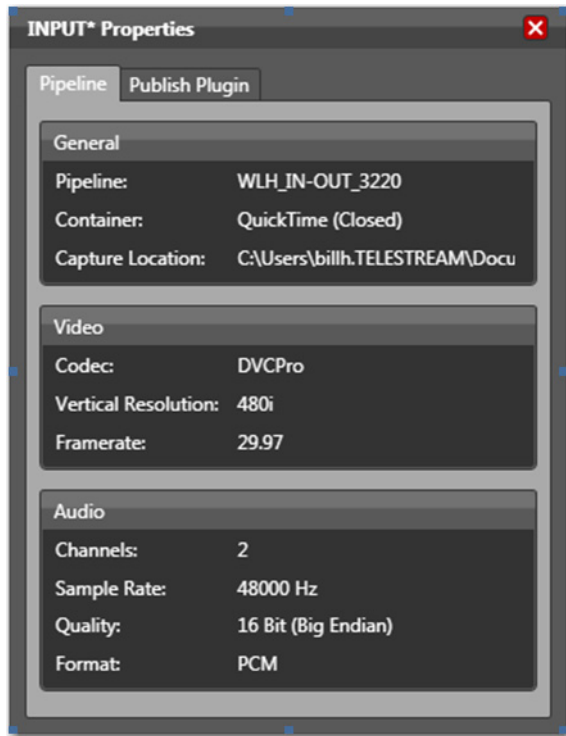

USING THE LABEL EDITOR

The Label Editor enables you to make your own metadata labels. Select Tools > Label Editor to display the Label Editor window.

To create a new label, click the plus (+) button located under Label Files on the left side of the panel. When a new label displays, double-click in the name field, enter a new label name, and press Enter. Click the minus (-) button to delete labels.

Double-click on the new parameter name displayed and rename. Using the drop-down menu on the right side of the window, set the parameter type to Text or True/False. Additional parameters are added by clicking the Add button. Parameters are deleted by clicking the Delete button.

Figure 6–37. Label Editor Window

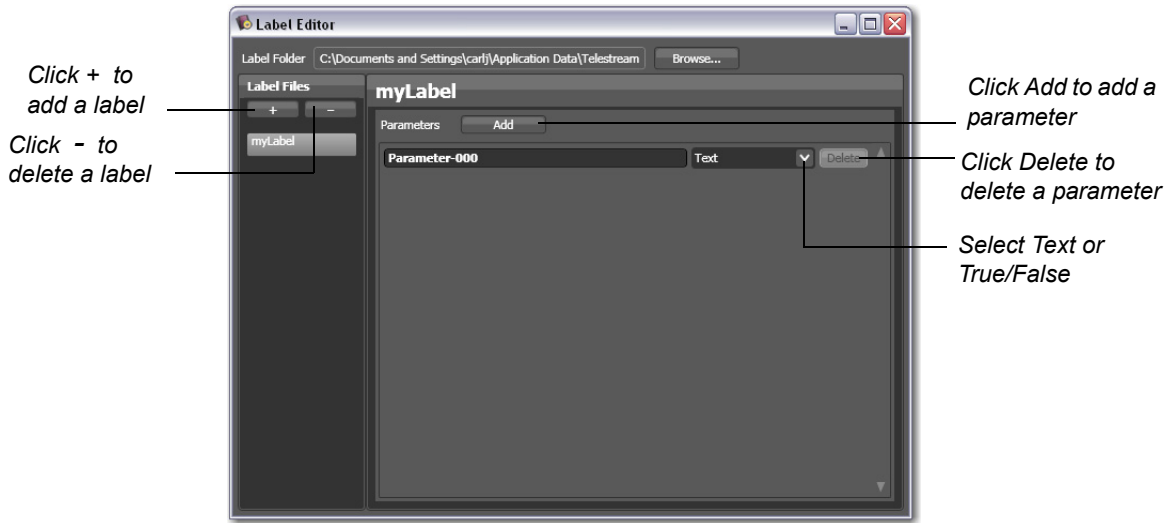

Labels are used throughout Pipeline Control as metadata that can be attached to clips. In the clip panel use the *Labels applied to new clips* drop-down menu to select a label to be used. Configure or set up the label as desired by checking any check boxes and entering parameter metadata.

Figure 6–38. Applied Labels Window

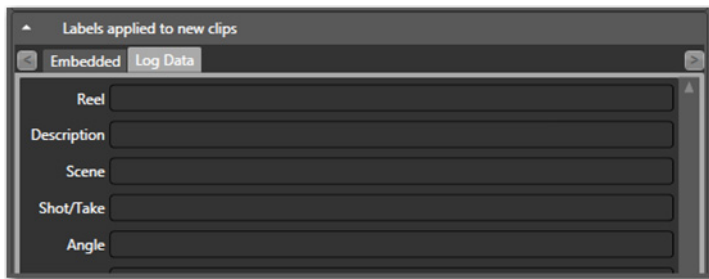

Note

The Reel field in the Log Data label has special properties. Data entered into this field will be automatically embedded in QuickTime and Avid MXF OP-Atom files as the Tape Name.

USING THE DIAGNOSTICS PANEL

The diagnostics panel provides easy access to a Pipeline device’s diagnostic and administration interfaces for trouble shooting and technical support. The diagnostic panel provides debugging information about Pipeline hardware and Pipeline Control that may be useful to Telestream Customer Service ([Obtaining Pipeline Support | Information | Assistance \(page i\)](#)).

For more details on troubleshooting, see [Gathering Information for Troubleshooting \(page 151\)](#).

To display or hide the diagnostics panel, click the collapse/expand arrow in the Diagnostics Panel title bar located in the lower left-hand corner of the Pipeline system window. (You may need to scroll down to bring the Diagnostics Panel into view).

Figure 6–39. Diagnostics window provides advanced information.

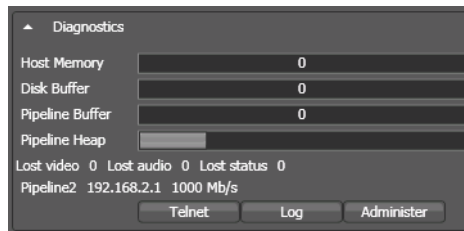

Host Memory. This meter indicates fullness of the frame buffer on the host computer during capture operations.

Disk Buffer. This meter indicates how many frames are in the buffer but have not been written to the destination.

Pipeline Buffer. This meter indicates fullness of the frame buffer in the Pipeline system.

Pipeline Heap. This meter indicates how much memory in Pipeline is being used and will expose memory leaks when it gradually moves toward maximum.

Lost Video, Lost Audio, Lost Status. These fields display the number of lost frame packets of each type (if any). The display also shows the name of the Network interface the Pipeline channel is using and the connected data rate (100Mb, 1000Mb, etc.).

Telnet. Click Telnet to display a Telnet session window providing access to the Pipeline that is connected. This information can be used to diagnose problems.

Log. Click Log to display information recorded during a Pipeline system crash.

Administrator. Click Administer to launch Pipeline Administrator in your Web browser.

During capture operations, low Host Memory meter readings are better; during playout operations, higher readings are better. The memory meters display the percentage of the video or audio (whichever is more full) frame buffer that is currently full.

During normal operations, the meter displays green. If the meter displays yellow, marginal conditions exist; red indicates that Pipeline Control is likely to underflow/overflow the buffer, which will cause the current operation to abort.

If disk buffering is enabled (available for certain wrapper formats), the Disk meter displays how much data is remaining to be transferred to its final destination (see Disk Buffering, below). When this grows, it indicates that Pipeline Control is no longer able to write to the final destination at the same speed it is receiving the data, which is usually caused by a network or I/O issue.

FILE FORMATS/WRAPPERS

Format Wrappers

Pipeline Control supports several industry-standard and proprietary wrappers: Avid AAF+MXF (OP-Atom), MXF (OP-1a), generic MXF (OP-Atom), QuickTime and TIFO (Telestream Intermediary Format). Pipeline

also supports many codecs to meet your compression needs: DV/DVCPPro, DVCPProHD, IMX, ProRes 422, DNxHD, Motion JPEG A (proxy format), MPEG-2 50Mbps I-Frame SD and Uncompressed 8 bit SD.

Avid AAF+MXF (OP-Atom)

Avid AAF+MXF produces MXF Operational Pattern Atom (OP-Atom) files compatible with Avid professional edit systems. It can be used with DV25, DVCPPro HD, IMX or DNxHD (VC-3) video essences. Avid AAF+MXF creates a unique set of files consisting of an AAF master clip file and individual MXF files for video and audio.

Workflow Considerations

The AAF file and associated media files can be delivered to separate folders that are specified in the Avid AAF+MXF selection dialog. Avid AAF+MXF files cannot be opened while they are being captured. Use Avid AAF+MXF when your workflow requires compatibility with Avid edit systems.

Output file naming:

- AAF/XML - <Filename>.AAF and <Filename>.XML,
(These files are used when importing into Avid edit software.)
- Video – Filename is generated by Avid Media Toolkit
- Audio – Filename is generated by Avid Media Toolkit

Table 6–2. Avid AAF+MXF Format Summary

Video	DV, DVCPPro, DVCPProHD, IMX, DNxHD
Audio	16 channels, 16/24 bit, 48 kHz, PCM/Dolby E
Timecode	SMPTE 377M timecode track
Closed captions	Essence storage only
Ancillary data	SMPTE 436M ANC track/atom

Table 6–3. Avid AAF+MXF Applicable Standards

Standard	Title	Notes
SMPTE 377M-2004	Material Exchange Format (MXF)	
SMPTE 390M-2004	MXF Operational Pattern Atom	
SMPTE 382M-2007	Mapping AES3 and Broadcast Wave Audio into the MXF Generic Container.	Each channel contained in a separate AES3 track/atom.
SMPTE 383M-2008	Mapping DV-DIF Data into the MXF Generic Container	Defines clip-wrapped DV-DIF essence.
SMPTE 386M-2004	Mapping Type D-10 Essence Data to the MXF Generic Container	Clip-wrapped D-10 is not defined (Avid is 2KB KAG padded, Apple is 512B KLV filled).
SMPTE 436M-2006	MXF Mappings for VBI Lines and Ancillary Data Packets	
SMPTE 2019-4-2008	Mapping VC-3 Coding Units into the MXF Generic Container	Defines clip-wrapped VC-3 essence.

Usage Considerations

The Avid AAF+MXF file wrapper can't be used in conjunction with Pipeline Control's Disk Buffer feature. Take extra care when writing Avid AAF+MXF files to shared disk subsystems.

The maximum length of an Avid AAF+MXF file captured in Pipeline Control is 9 hours. When using a Scheduled Capture document, no event can exceed 9 hours. Capturing an Avid AAF+MXF file in a Trigger document without first specifying a duration results in a file that reports the exact duration of the recorded event.

When you select Avid AAF+MXF format, Pipeline Control displays this configuration dialog:

Figure 6–40. Avid AAF+MXF Dialog Box

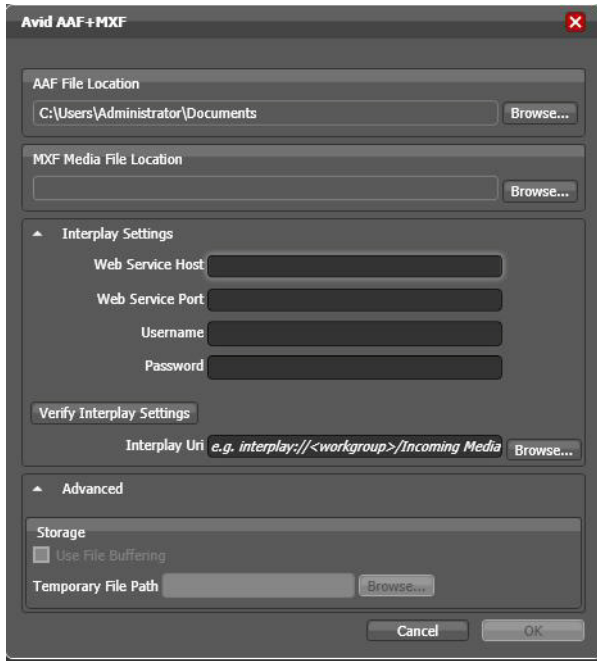

AAF File Location. Click Browse to navigate to the desired storage location for the Avid AAF file. This file must be saved to a local destination on the Pipeline host. Though the AAF file is not used when registering assets via Interplay, Pipeline Control still requires a local path.

MXF Media File Location. Click Browse to navigate to a media directory for the MXF audio and video files associated with this clip. Typically, this is the *AvidMediafiles/MXF/1* folder used by the Avid edit system. This folder can be local or shared storage.

Interplay Settings. Interplay is a production asset management system from Avid. With Interplay media assets can be instantly checked into the asset management database and made available to Interplay clients for immediate access, even while they are still being captured.



Note

Avid Frame Chase editing (edit while capture) can be performed on assets checked into Interplay by Pipeline Control. The assets Video track is updated automatically every 600 frames. However, Audio tracks must be updated manually by selecting “Update from Interplay” within Avid Media Composer.

Requirements for using Pipeline with Interplay asset check-in

In order to check-in Pipeline Control captured media assets into an Interplay Production Asset Management system you must first have an Interplay system, version 2.2 or later, with all the appropriate Avid processes to support Interplay access to indexed media assets.

In addition to a working Interplay system you will also need to have Interplay Web Services installed on your Interplay system. Interplay Web Services are not installed or distributed by default. Your Interplay

administrator will need to acquire, install and configure Interplay Web Services before Pipeline with Interplay asset check-in can be used.

Interplay Web Services must be configured to run using an open port on the Interplay server or servers. Your Interplay administrator should install and configure Interplay Web Services on an appropriate server using any available port.

The Pipeline host system (running Pipeline Control software) must be a client of the Avid storage system allowing it to write media files to the Avid Interplay workspace.



Note

Avid recommends that:

- *Interplay Web Services are installed on a completely separate machine to the Interplay database.*
- *No more than 5 consecutive connections can be triggered at the same time on an Avid Web service machine. If capturing multi-feeds the first 5 can start simultaneous with the start of the 6th or more staggered by 1 second or more.*

Always connect to Interplay and Web Services using a fully qualified DNS name. (Register with Forward and Reversed look up tables in the DNS.).

Configuring the Pipeline AAF+MXF with Interplay Settings

AAF File location The AAF file must be saved to a local destination on the Pipeline host. Though the AAF file is not used when registering assets via Interplay, Pipeline Control still requires it to be written to a local path.

MXF Media file location When checking captured media assets into Interplay this location must be an Avid storage workspace being indexed by Interplay.

Web Services Host This is the Interplay Web Service host name or IP Address.

Web Service Port This is the port to which the Interplay Web Service is set.

Interplay URI Interplay Web Services uses a string referred to as the *Interplay URI* to reference media assets. This URI can have several forms, but it always begins with *interplay://<workgroup>* where <workgroup> is the workgroup name configured to point to the Interplay Engine. The workgroup setting should follow the location of the project folder where captured media assets are referenced.

You can either enter the URI directly, in the form of: *interplay://<workgroup>/<project folder>*, or you can click *Browse* and navigate to the URI location.

Username and Password These are the Username and Password required to log into the Interplay Server.

Testing your Interplay settings When all Interplay information is entered, select *Verify Interplay Settings* to verify that all settings are entered correctly.

MXF (OP-1a)

Workflow Considerations

Opened Open MXF produces an MXF Operational Pattern 1a (OP-1a, SMPTE 379M-2004) file with a generic container mapped to DV, DVCPPro, DVCPPro HD, IMX or DNxHD (VC-3) video essence.

Use Open MXF when your workflow requires the video and audio essence to be wrapped in a single file meeting the SMPTE 379M-2004 generic MXF specification. To produce an MXF D-10 file use Open MXF in conjunction with the IMX video codec.

Closed Produces an MXF Operational Pattern 1a (OP-1a) file compatible with Sony XDCAM with essence containers mapped to DV, DVCPro, DVCProHD, IMX or DNxHD (VC-3). These files can't be opened while they are being captured.

Use 'Closed' when your workflow requires the video and audio essence to be wrapped in a single file compatible with Sony XDCAM MXF or when capturing MXF (OP-1a) clips to be imported into an Avid system.

Table 6–4. Generic MXF Format Summary

Video	DV, DVCPPro, DVCPProHD	IMX	DNxHD
Audio	16/24 bit, 48 kHz		
	16 channels	8 channels	16 channels
	PCM/Dolby E	PCM/DolbyE	PCM/Dolby E
Timecode	SMPTE 377M Timecode track		
	SMPTE 385M System item		SMPTE 405M System item

Table 6–5. MXF Applicable Standards

Standard	Description	Notes
SMPTE 331M-2004	Elements and Metadata Definitions for SDTI-CP	
SMPTE 377M-2004	Material Exchange Format (MXF)	
SMPTE 378M-2004	MXF Operational Pattern 1a	
SMPTE 379M-2004	MXF Generic Container	
SMPTE 382M-2007	Mapping AES3 and Broadcast Wave Audio into MXF Generic Container	DV (AES3), DNxHD (BWF)
SMPTE 383M-2008	Mapping DV-DIF Data into MXF Generic Container	DV
SMPTE 385M-2004	Mapping SDTI-CP Essence and Metadata into MXF Generic Container	DV, IMX
SMPTE 386M-2004	Mapping Type D-10 Essence Data to MXF Generic Container	IMX
SMPTE 394M-2006	System Scheme 1 for MXF Generic Container	DNxHD
SMPTE 405M-2006	Elements and Individual Data Items for MXF Generic Container System Scheme 1	DNxHD
SMPTE 436M-2006	MXF Mappings for VBI Lines and Ancillary Data Packets.	
SMPTE 2019-4-2008	Mapping VC-3 Coding Units into MXF Generic Container	DNxHD
SMPTE RDD03	eVTR MXF Interoperability Specification	DV, IMX

The resulting MXF (OP-1a) file can contain VANC data (SMPTE 436M) if present within the incoming SDI stream.

Usage Considerations

Due to the structure of an MXF OP1a *Closed* file container these files cannot be used in conjunction with Pipeline Control's Disk Buffer feature. Take extra care when writing MXF (OP-1a) *Closed* files to network disk subsystems.

The maximum length of an MXF (OP-1a), *Open* or *Closed* file, captured with Pipeline Control is 9 hours.

Pipeline system's MXF OP-1a *Closed* files always results in an MXF file that reports the exact duration of the recorded event, even if stopped prior to reaching its initial duration. In contrast when capturing MXF OP1a *Open* the duration contained in the file will report the initial duration even if stopped prior to reaching that duration. If no duration is specified MXF OP1a *Open* files will report a duration of 9 hours.

These files can be added to Final Cut Pro systems by using Flip4Mac MXF or MXF4Mac components, and to Avid Media Composer systems utilizing the Avid AMA MXF plug-in.



Note

MXF OP1a files created for ingest into Avid Media Composer via AMA cannot contain a VANC track. This is a limitation of the currently release of Avid Media Composer.

When you select MXF (OP1a) format, Pipeline Control displays this configuration dialog:

Figure 6–41. MXF OP-1a Dialog Box

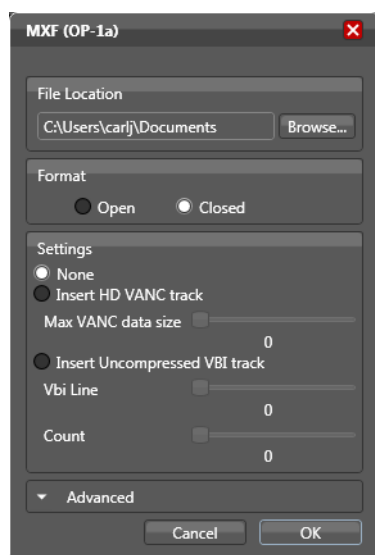

File Location. Click Browse to navigate to a storage directory for your media files.

Format – Open. MXF OP1a produces an MXF Operational Pattern 1a (OP1a, SMPTE 379M-2004) file with a generic container mapped to DV, DVCPRO, DVCPRO HD, IMX or DNxHD (VC-3) video essence.

Use Open MXF when your workflow requires the video and audio essence to be wrapped in a single file meeting the SMPTE 379M-2004 generic MXF specification. To produce an MXF D-10 file use the IMX video codec.

Format – Closed. MXF OP1a produces an MXF Operational Pattern 1a (OP1a) file compatible with Sony XDCAM with essence containers mapped to DV, DVCPRO, DVCPRO HD, IMX or DNxHD (VC-3). These files cannot be opened while they are being captured.

Use Closed when your workflow requires the video and audio essence to be wrapped in a single file compatible with Sony XDCAM MXF or when capturing MXF OP1a clips to be imported into an Avid system.

Settings. Within the Settings section you can choose None, Insert HD VANC track, or Insert Uncompressed VBI track. These settings are only applicable when capturing from a Pipeline HD Dual channel.

Select *None* if you do not require SMPTE 436M data.

Select *Insert HD VANC track* if you require HD VANC data to be inserted in accordance with SMPTE 436M standard. Use the slide bar to set VANC data size from 64 to 65K.

Select *Insert Uncompressed VBI track* if you require SD Uncompressed VBI data to be inserted in accordance with SMPTE 436M standards. Use the VBI Line slide bar to select the first VBI line. Use the Count slide bar to select the number of lines. When inserting Uncompressed VBI you must also set the firmware option [Capture uncompressed VBI lines \(HD units only\)](#) for SD codecs only.

Advanced. Select if Data Disk Buffering will be used. Browse to the local disk buffering disk location. See [Disk Buffering Details \(page 36\)](#) for details.

Generic MXF (OP-Atom)

Workflow Considerations

MXF (OP-Atom) produces MXF Operational Pattern Atom (OP-Atom) files compatible with professional edit systems. MXF (OP-Atom) can be used with DV/DVCPro, DVCProHD, IMX or DNxHD (VC-3) video essences. MXF (OP-Atom) creates a unique set of files consisting of individual MXF files for video, audio and Data. A separate MXF file will be created that contains any VANC data present within the incoming SDI stream.

Output file naming:

- Video - <Filename>.MXF
- Audio - <Filename>nn.MXF, where 'nn' is a number between 00 and 15
- Data - <Filename>D.MXF

Pipeline's MXF (OP-Atom) files are not intended to be used with Avid Media Composer MXF AMA plug-in. Use Avid Media Tool directly or Interplay to add them to your media database.

Table 6–6. MXF OP-Atom Format Summary

Video	DV, DVCPro, DVCProHD, IMX, DNxHD
Audio	16 channels, 16/24 bit, 48 kHz, PCM/Dolby E
Timecode	SMPTE 377M timecode track
Closed captions	Essence storage only
Ancillary data	SMPTE 436M ANC track/atom

Table 6–7. MXF OP-Atom Applicable Standards

Standard	Title	Notes
SMPTE 377M-2004	Material Exchange Format (MXF)	
SMPTE 390M-2004	MXF Operational Pattern Atom	
SMPTE 382M-2007	Mapping AES3 and Broadcast Wave Audio into the MXF Generic Container.	Each channel contained in a separate AES3 track/atom.
SMPTE 383M-2008	Mapping DV-DIF Data into the MXF Generic Container	Defines clip-wrapped DV-DIF essence.

SMPTE 386M-2004	Mapping Type D-10 Essence Data to the MXF Generic Container	Clip-wrapped D-10 is not defined (Avid is 2KB KAG padded, Apple is 512B KLV filled).
SMPTE 436M-2006	MXF Mappings for VBI Lines and Ancillary Data Packets	
SMPTE 2019-4-2008	Mapping VC-3 Coding Units into the MXF Generic Container	Defines clip-wrapped VC-3 essence.

Usage Considerations

The MXF (OP-Atom) file wrapper can be used in conjunction with Pipeline Control's Disk Buffer feature.

The maximum length of an MXF (OP-Atom) file captured in Pipeline Control is 9 hours. When using a Scheduled Capture document, no event can exceed 9 hours. Capturing an MXF (OP-Atom) file in a Trigger document without first specifying a duration results in a file that reports the exact duration of the recorded event.

When you select MXF (OP-Atom) format, Pipeline Control displays this configuration dialog.

Figure 6–42. MXF OP-Atom Dialog Box

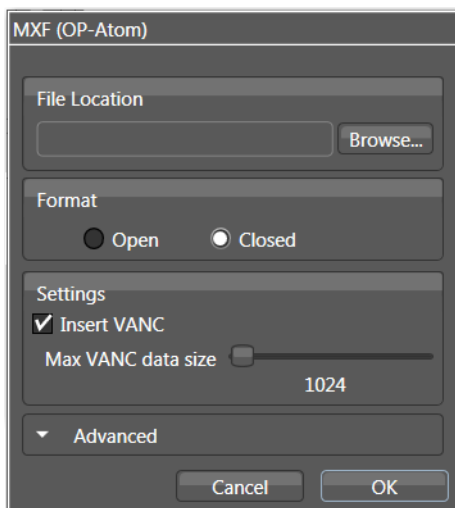

File Location. Click Browse to navigate to a storage directory for your media files.

Format – Open. Open pre-allocates a fixed file size. Use Open MXF OP-Atom when your storage system requires that you pre-allocate all the space you will need up front.



Note

Open MXF OP-Atom files can only be written to the local attached storage folders, shared Windows-based file system folders, or Windows-based file system NAS folders.

Format – Closed. Closed allocates the file size as the video is ingested. This is the default method of creating MXF OP-Atom.

Settings Insert VANC. VANC data can be inserted in accordance with SMPTE 436M standard. Use slide bar to set VANC data size from 64 to 65K.

Advanced. Not applicable for this wrapper type.

QuickTime

QuickTime 'Open' files created by Pipeline Control can be edited in Final Cut Pro (and other media edit applications) as they are being captured. Use the 'Open' or 'Open+Ref' file format if you will be editing or reviewing (playing out in QuickTime player) while capturing. Because of this unique characteristic Pipeline's 'Open' QuickTime files initially set the header with the duration entered or if an overall duration is not specified with the maximum duration of 9 hours. In most circumstances the actual final duration is updated after the capture is complete. The one exception is when Disk Buffering is employed. In this case the duration will be that which was initially updated or the maximum duration of 9 hours.

Workflow Considerations

Be aware of the disk I/O implications of an edit while capture workflow by reading Typical Pipeline Systems and Considerations in the Pipeline Control User Guide.

QuickTime 'Closed' files are traditional QuickTime files that can't be opened while they are being captured. Use 'Closed' files if you will not be editing or reviewing (playing out in QuickTime player) while capturing.



Note

When writing files to a shared folder on a Windows computer, the security settings must allow full read/write for the user accessing the file for edit.

Table 6–8. QuickTime Open Format Summary

Video	SD, Motion JPEG-A, DV, DVCPPro, IMX, MPEG2-I, DVCPProHD, ProRes, DNxHD
Audio	16 channels, 16/24 bit, 48 kHz, 1/2 channels per track
Timecode	Timecode ('tmcd') track
Closed captions	Closed caption ('clcp') track, EIA-608 caption data
Ancillary data	Essence storage only

Table 6–9. QuickTime Open Applicable Standards

Standard	Title
IEC 14496-14	MP4 File Format
	QuickTime File Format Specification

Usage Considerations

The maximum length of an open QuickTime file captured in Pipeline Control is 9 hours.

If closed captions are available in the source during capture, they are automatically embedded into a

QuickTime closed caption track. When played in QuickTime Player, the closed caption data is overlaid on the video by selecting View > Show Closed Captioning.

These files can be added to Final Cut Pro systems directly or to Avid Media Composer v5 systems utilizing the Avid AMA QuickTime plug-in.

When you select QuickTime format, Pipeline Control displays this configuration dialog.

Figure 6–43. QuickTime Dialog Box

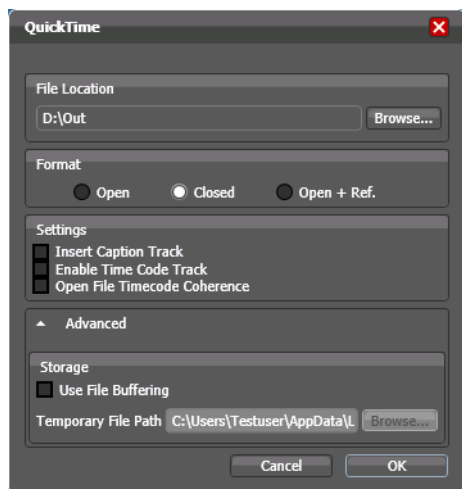

File Paths Storage. Click Browse to navigate to a storage directory for your media files.

Format Open/Closed. Select Open or Closed QuickTime format.

Format Open/Closed/Open+Ref. Select the desired QuickTime format: Open, Closed or Open + Ref

- Open: Open files are written in a way that allows some application to read it while capture is still in progress. These files are pre-indexed and will be larger than traditional QuickTime files.
- Closed: Closed QuickTime files are created in a traditional way and cannot be opened while they are being written to.
- Open + Ref: If selected an Open and QuickTime reference file are created concurrently to the selected file location. The reference file will be named [FILENAME].ref.MOV.

Settings - Insert Caption Track. Check *Insert Caption Track* to insert a track for captioning.

Settings - Open File Timecode Coherence. Check *Open File Timecode Coherence* to cause the QuickTime file writer to lay down incoming frames at the correct position in the QuickTime movie. When input discontinuities occur, empty frames are inserted so that the timecode stays in sync. If input discontinuities are ignored, empty frames in the middle of the movie will result, but the timecode will be correct for all good frames.

Advanced. Select if Data Disk Buffering will be used. Browse to the local disk buffering disk location. See [Disk Buffering Details \(page 36\)](#) for details.

Telestream Intermediary Format (TIFO)

Telestream Intermediary Format (TIFO) is an intermediate media wrapper format designed by Telestream as a uniform, interchangeable file format to ensure inter-operability among Telestream's media processing solutions, including FlipFactory, Vantage, Wirecast, Episode, and Pipeline. TIFO provides a lightweight,

low-overhead wrapper that is essence-agnostic, with out-of-band metadata, timecode, and closed caption support.

Using TIFO improves the ability to move media files between Telestream's media processing solutions with all media essence elements and metadata intact, preserving the widest range of transcoding options.

Workflow Considerations

TIFO format should be used when you are encoding your files for use with FlipFactory, Vantage or Episode. TIFO files are unique, in that they can be transcoded as they are being captured in FlipFactory, Vantage, Episode 6 and Episode Engine, enabling you to create multiple output files in real-time. TIFO files can also contain metadata such as closed captions, ancillary data and timecode, which can be processed by FlipFactory, Vantage or Episode for processing in workflows that retain this data.

Table 6–10. TIFO Format Summary

Video	SD, Motion JPEG-A, DV, DVCPPro, IMX, MPEG2-I, DVCPProHD, ProRes, DNxHD
Audio	16 channels, 16/24 bit, 48 kHz
Timecode	Video sample header
Closed captions	Video sample parameter (“ATOM”)
Ancillary data	Video sample parameter (“ATOM”)

When you select TIFO format, Pipeline Control displays this configuration dialog:

Figure 6–44. TIFO Dialog Box

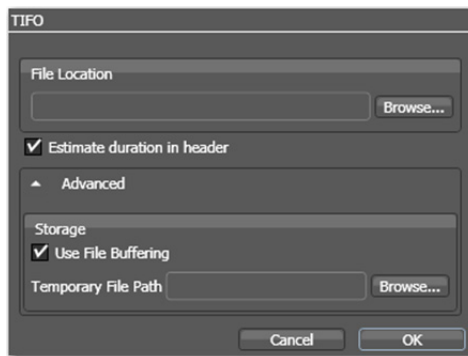

File Location. Click Browse to navigate to a storage directory for your files.

Estimate Duration in header. Check this box if you are writing files to be processed by Episode. TIFO version 4 adds an anticipated duration to the file header which allows applications using TIFO to display an accurate progress bar while processing these files.

Advanced. Select if Data Disk Buffering will be used. Browse to the local disk buffering disk location. See [Disk Buffering Details \(page 36\)](#) for details.

CHAPTER 7

Using Scheduled Capture Documents

Use this chapter to learn how to use Pipeline Control to create schedules for capturing media from Pipeline. Capturing media on a schedule is achieved using the Scheduled Capture document in Pipeline Control.



Note

You can only play out schedule documents in Pipeline Control on Mac OS X. Use the Controlled Playout document for similar results on Windows OS.

Topics

- [Using The Scheduled Capture Document \(page 108\)](#)
- [About Schedules \(page 108\)](#)
- [Creating Capture Schedules \(page 109\)](#)
- [Using the Schedule Panel \(page 110\)](#)

USING THE SCHEDULED CAPTURE DOCUMENT

The Scheduled Capture (schedule, for short) document is designed to facilitate the creation of clip capture schedules.

Figure 7–1. Schedule window panels and toolbars.

Settings Panel. Use to configure Pipeline for use in this schedule.

Schedule Toolbar. Provides buttons for frequently used functions.

Schedule/List View buttons.

Status Panel. Displays status.

Video Panel. Displays video.

Timecode. Displays when connected.

VTR Controls. Use to play video.

Audio Panel. Displays volume by channel.

Diagnostics Panel.

Activation Slider.

Schedule panel. Displays all clips in a timeline.

Event Timer. Indicates current time in schedule.

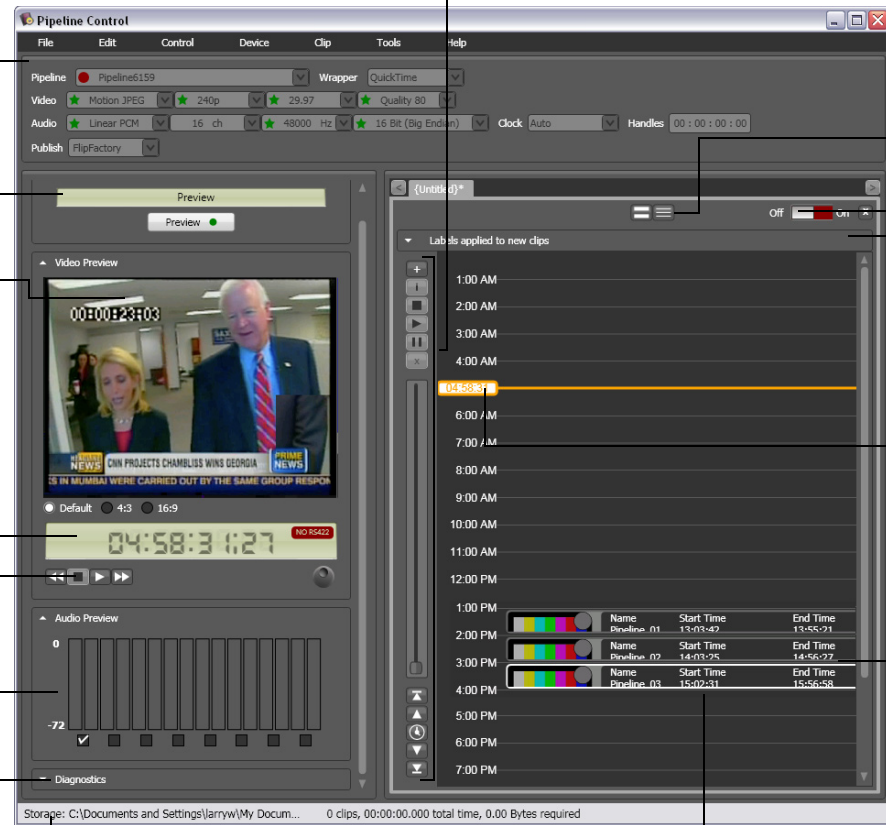

Schedule Details. Displays number of clips, total capture hours, and approx. space required.

Clips. Add these clips to capture on schedule.

Pipeline Control displays several panels and toolbars to help you perform the tasks the document was designed to facilitate.

The schedule document is composed of a 24-hour schedule panel (on the right), with Pipeline Status, Video Preview, Audio Preview, and Diagnostics panels on the left. You can open multiple documents at a time – each is displayed in its own tab.

ABOUT SCHEDULES

A *schedule* is a list of one or more clip events to be processed in a recurring 24-hour period. Each schedule also has information about Pipeline selection and settings, and optional publisher specifications. Each schedule document is displayed in a different tab. Because Pipeline Control is a multi-document application, you can open, edit, and execute several schedules (or other documents) at the same time.

The number of media files you can capture or play out simultaneously is based on the power of the CPU and disk write speed in your computer and your network bandwidth ([Disk and Network Requirement by Media Format on page 38](#)).

Creating Schedules. To create a schedule, select File > New Schedule to display a new schedule document. To save a schedule, select File > Save or Save as, name the document and select a folder to save it in. When you save a schedule, it is saved as a document. You can copy Pipeline Control documents and move them to other folders or other computers. You can work with Pipeline Control documents just like you do any other document.

When you close a schedule window, if it hasn't been saved before, you'll be asked to name it. If you've changed it, you'll be asked if you want to save changes



Note

Active schedules must first be deactivated to close them. You may be interrupting a clip capture — so check first.

Each schedule contains several groups of information: the selected Pipeline and its settings, plus a list of one or more clips arranged in a 24-hour time line, their name and optional metadata, and publishers, if any. Pipeline Control uses the schedule information to execute each clip event (at the correct time) to either capture or playout the clip (playout is available on Mac OS X only).

Schedules are Symmetrical. That is, if you *capture* a given schedule, Pipeline Control runs the schedule and ingests encoded media from a specific Pipeline's SDI port based on the clip events you've created in the schedule, and saves it as a specific type of file, based on your settings. On Mac OS X, you can also *play out* the same schedule and the reverse occurs: each file you specify with a clip event is opened at the correct time and the media is played out to the specified Pipeline for decoding and playout as SDI.

You can create and configure as many schedules as you need to organize your Pipelines, workflows, and tasks efficiently. You might create schedules for each Pipeline you're using, or you might create schedules for a specific set of clips you need to capture or play out each day (or work shift). Or, you can create schedules based on how you want the media encoded, for use in an edit system, for example.

Pipeline Control will automatically reconnect a schedule document if network connectivity or video signal is lost, and continue processing events. If an event is being recorded or played out, the file (or output of the file) is invalid.

CREATING CAPTURE SCHEDULES

A *capture* schedule is a schedule with one or more clips, which you use to capture SDI video in real time. The SDI video is converted to a specific media format, depending on the codec you specify in the Pipeline, and saved as a digital media QuickTime or TIFO file by Pipeline Control.

Here are the steps you'll take to create and use a capture schedule:

1. If Pipeline Control isn't running, start it now ([Starting Pipeline Control on page 59](#)).
2. Create a new, untitled Scheduled capture document (Select File > New Schedule) if one isn't open.
3. Select the Pipeline device which is supplying the video feed you want to capture ([Selecting a Pipeline \(page 65\)](#)).
4. Select the video codec and configure it to meet your video encoding requirements ([Selecting and Configuring a Video Codec \(page 66\)](#)).

5. Likewise, configure the audio codec to meet your audio encoding requirements ([Configuring the Audio Codec \(page 67\)](#)).
6. Specify your timecode clock source ([Selecting a Timecode Clock Source \(page 67\)](#)).
7. Select your wrapper (file) format ([Selecting and Configuring Codecs \(page 65\)](#)), configure it, and specify the storage location where you want your media clips saved.
8. Set up handles as necessary ([Setting up Handles \(page 68\)](#)).
9. Optionally, select and configure a publisher to perform additional actions as part of a workflow ([Selecting a Publisher \(page 68\)](#)).
10. Save your schedule and name it, then continue.
11. Add one or more clip events to the schedule ([Creating Clip Events \(page 112\)](#)).
12. For each clip, enter a file name if you want it to be different than the default, and optionally, select a metadata label and enter metadata ([Editing a Clip Event's Property Sheet \(page 114\)](#)).
13. Save the schedule.
14. Click Capture to place the schedule into capture mode.

Pipeline Control displays the incoming video stream – verify the stream is what you expect. Pipeline Control waits for each clip event, and saves each clip as a file using the settings you specified.

USING THE SCHEDULE PANEL

The schedule panel (on the right side of the window) is a vertically-oriented view of a 24-hour period. A time scale displays on the left, with space on the right to add clip events. The time is controlled by the timecode clock source you specify.

Figure 7–2. The schedule panel allows you to create clip events.

Schedule/List View. Click to display the full event list in schedule view or just display the list of clip events.

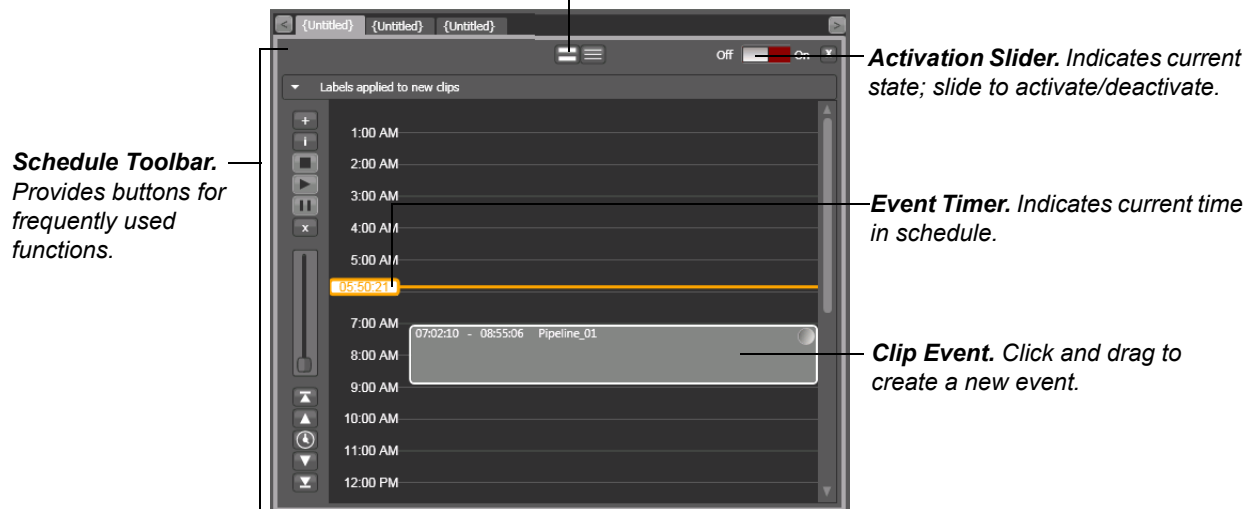

At the far left is a toolbar with buttons for frequently used functions. Above the event area is a Schedule/List view button that enables you to display the complete schedule or just a table of events.

Activation Slider. Click to activate (place the schedule in active mode) the schedule, when connected to a Pipeline. Clip events are captured as files as they occur in the schedule. In this mode, locks display on clips and you can't edit the schedule (add, edit, delete or play clips) or change your settings. When a clip event is executed, the current settings in the Pipeline Settings panel are used, even if they are not saved. Pipeline Control does not automatically save settings. To save settings, select File > Save.

When you activate a schedule, Pipeline Control checks to make sure you have enough space for the clip events on your schedule.

For a schedule to remain active, the Pipeline Control application must be open and the Schedule document must also be open. If the Pipeline Control application or the Schedule document is closed, clip events aren't executed.

Clip Events

You add clip events by clicking and dragging the mouse in the schedule panel.

Figure 7–3. Clip events in your schedule provide details about the clip.

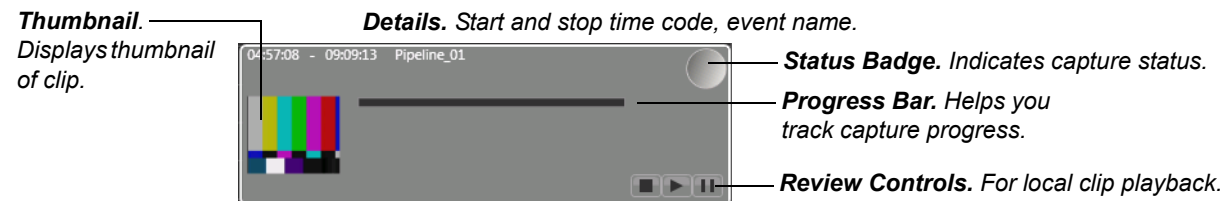

When you add a new clip event by clicking the Add Clip button, it is created on the nearest half hour. You can resize a clip (up to 9 hours long) by dragging either the top or bottom and resizing it. You can also snap to present lengths at half the displayed timescale. For example, with the timescale displaying 1 minute increments, snap to 30 second increments by pressing the control key while resizing the clip. To snap the top time, control-click and drag the top of the event.

You can zoom in to increase your view of the schedule with greater detail, and create smaller clip lengths. You can also edit the time down to the second by right-clicking the clip event and selecting Edit (or select the clip then select Clip > Edit) to display its property sheet.

Preview Thumbnail. Assigned when you created the mark-in point.

Status Badge. Status badge (Table 7–1 on page 112) to indicate the state of this clip.







Progress Bar. When capturing, colored yellow for captured and green for written to disk, indicating progress toward completion.

Review Controls. When file has been captured and closed, use these controls to view your clip locally.

Clip Status Badges

Each clip is marked with status badges to help you identify the state of each clip at a glance.

Table 7–1. Status badges and their descriptions.

Status Badge	Description
	Pipeline Control attempted to capture the clip, but failed. This may be due to lack of storage, network or Pipeline problems, or excessive pre-roll at the beginning of a tape, for example. Resolve the problem and retry. Using the mouse, hover over the icon to display additional information.
	This clip is being closed. All media has been captured, but it has not been completely written to the file yet – possibly due to use of buffering.
	This clip event has not been captured yet.
	This clip is currently being opened/created, but no media has been captured yet.
	This clip is in the process of being captured.
	This clip has been successfully captured and the file has been closed.

Schedule Panel Keyboard Shortcuts

You can work with clips in your schedule using the following keyboard shortcuts:

Delete | Backspace. Deletes the selected clip event

Page Up. Select the previous clip event

Home. Select the first clip event

Page Down. Select the next clip event

End. Select the last clip event

Up Arrow. Move the selected clip up the schedule by the current block size (half hour, quarter hour, minute, thirty seconds, etc.), based on your current zoom increment.

Down Arrow. Moves the selected clip event down by the current block size.

Creating Clip Events

To add a clip event to a schedule, choose one of two actions:

- Move your cursor into the schedule panel and position it at the approximate start time. Now, click and drag downward for a maximum of 9 hours or until the end of the clip event (you can adjust the time accurately later) and release the button.

OR

- Click the Add Clip icon (the plus sign icon) at the top of the schedule toolbar or select Clip > Add.

Once a clip has been added to the schedule, you can drag it up and down the timeline to change the start/stop time. Or, open the property sheet (right-click and select Edit or select the clip then select Clip > Edit) and adjust the start and stop time. You can't create a single clip event lasting longer than 9 hours.

When clips are captured, they are saved in the folder specified by the storage location in your wrapper.

You can move a clip by clicking in the clip event and dragging it up or down. This avoids the necessity of moving a clip by adjusting both the start and stop times correctly. You can't overlap clip events on a schedule.

To play a clip that has been captured, use the review controls.

Deleting Clip Events.



Note

This will not delete the captured clip, just the event.

To delete a clip event you've selected, choose one of these actions:

- Press the Delete key or the Backspace key.
- Click the X icon to the left of the schedule
- Right-click and select Clear from the context menu.

Once a clip has been placed on the schedule, you can drag it around to change their times. Or, you can open the property sheet and adjust their start and stop time. You can't create a single clip event lasting longer than 9 hours.

Showing Media on Your Desktop

When an event is connected to a local file, you can open the folder that contains the file directly.

Pipeline Control sends a command to the operating system to display the clip in the enclosing folder:

Figure 7–4. Pipeline Control displays the video clip’s folder.

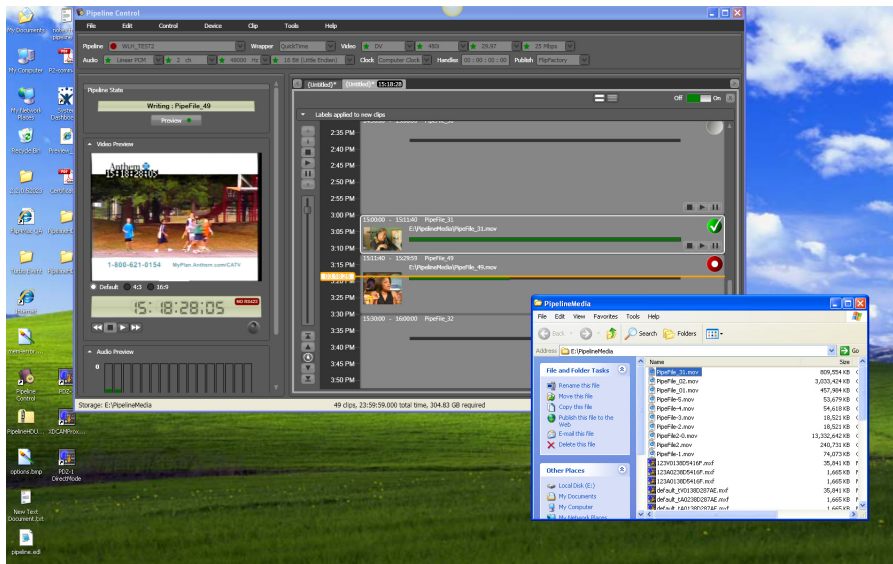

Editing a Clip Event’s Property Sheet

Each clip event has its own property sheet. To display a clip event’s property sheet:

- Select the event and select Clip > Edit
- Select the clip and click the *i* icon in the toolbar to the left of the timeline
- Right-click to display the context menu and select Edit.

Properties are displayed in General and Embedded tabs, and other metadata tabs based on publishers.

Viewing and Updating General Properties

To view or update the general properties of an event, select the clip, then select Clip > Edit. Click the General tab to display this sheet. Alternatively, hover over the event and right-click to select Edit on the context menu.

Figure 7–5. Clip event general properties.

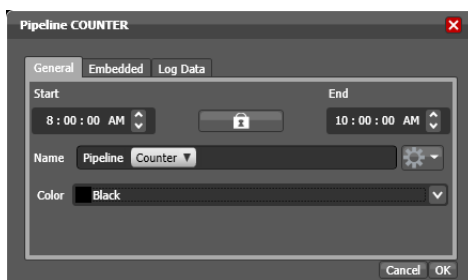

Start and End Time. Edit the digital clock to adjust the start and end times of the clip event.

Lock. Click the lock (to display the locked icon) to cause Pipeline Control to adjust the start or end time while maintaining the duration. Click again (to display the unlocked icon) to modify the duration.

Name. Enter a name for the clip in the text field and, optionally, select naming tokens..



Note

If you want the video files to be overwritten on a 24-hour basis you can use the mark-in token.

Color. Select a color to use when displaying this clip event in the schedule panel.

Click OK to save your changes or click Cancel to leave them unchanged.

Viewing and Updating Metadata Labels

To view or update the label values of a clip event, edit the clip. Then, to display this sheet, click the Labels tab you want to edit (there may be more than one metadata label). The Embedded label is always available. Other labels (including FlipFactory labels, Final Cut Pro, and QuickTime) are displayed appropriately.

Values you enter in the Embedded label are stored directly in the file that is created.

Figure 7–6. Clip event label values.

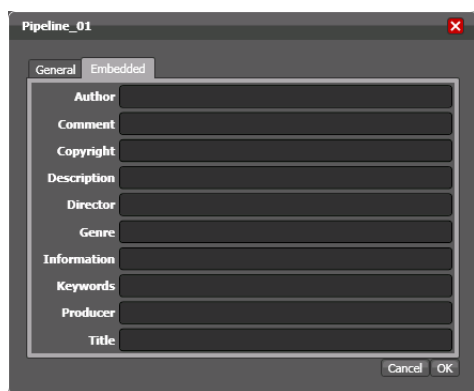

Click OK to save these values or click Cancel to leave them unchanged.

Log Data.

At any time when a clip list is displayed, you can view or edit metadata. To view or edit metadata, click the *Log Data* tab to display the log data:

Figure 7–7. Log Data.

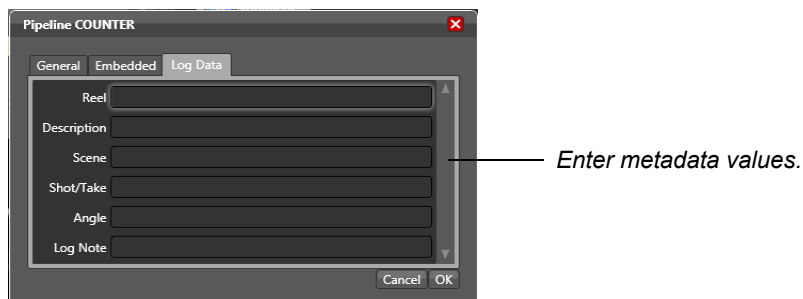

Edit the values for each metadata tag, Click OK to close the window and save the metadata.

Using the Schedule Toolbar

The schedule toolbar displays vertically, on the left of the schedule panel. It provides easy access to various schedule commands you use to create and manage clip events.

Figure 7–8. Schedule Toolbar.

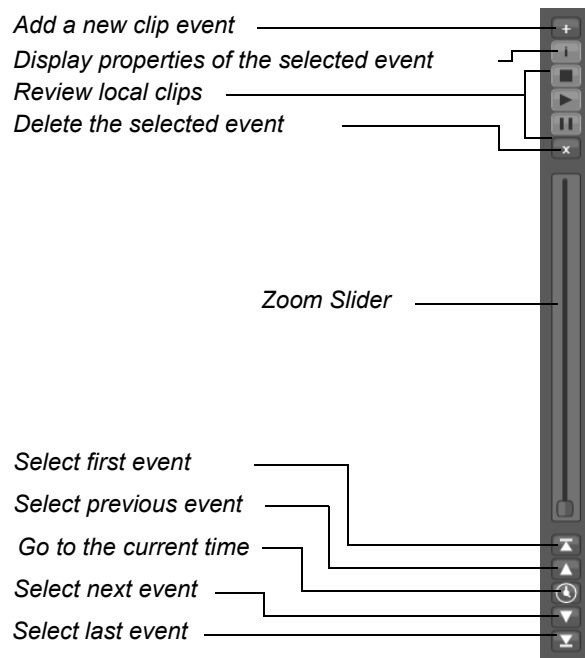

Add Clip. Use to add a new clip event. Each time you add an event, it is added as early in the schedule as possible, where space is available. The newly-created clip is automatically selected so that you can immediately display its properties and add metadata, or adjust start and stop times.

Information. Click to display the property sheet for the selected clip.

Review. Play the local clip (after its been captured) of the selected event in the Video Preview panel.

Delete. Click to remove the selected clip event from the schedule. When you remove a clip event, the actual file that it references (if present) is left intact – it is not deleted.

Zoom. When you zoom out all the way, on most monitors you can view the entire schedule from an hourly perspective. As you zoom in closer and closer, you can view half and quarter hours, 5 minutes, one minute. Zoom to the magnification that is best for the size of clips you’re working with.

You can also zoom the schedule by repeatedly clicking the left arrow (to zoom out) or right arrow key (to zoom in).

Select and show the first event. Click to select and zoom in on the first event in the schedule.

Select and show the previous event. Click to select and zoom in on the event immediately prior to the currently-selected clip.

Go to Current Time. With the time source (Auto, RS-422, etc.) and Pipeline selected, click to scroll the schedule so that the current time is as close to the center of the schedule as possible, so that it is visible. If you are not connected to a Pipeline device, Pipeline Control displays the schedule beginning at midnight.

Select and show the next event. Click to select and zoom in on the next event after the selected clip.

Select and show the last event. Click to select and zoom in on the last event in the schedule.

CHAPTER 8

Using Log & Capture Documents

You can use Log & Capture documents in Pipeline Control to create and save clip lists, and capture media defined by the clips in various formats via Pipeline, independently of your video editing/encoding software.

You can capture and encode clips in any supported SD or HD essence and file format/wrapper.



Note

When capturing media from Pipeline Quad, you can perform confidence monitoring to qualify your video. See [Confidence Monitoring \(page 51\)](#).

Topics

- [Creating Clip Lists for Log and Capture \(page 117\)](#)
- [Using the Log & Capture Document \(page 118\)](#)
- [Using Log & Capture Controls in the Preview Panel \(page 119\)](#)
- [Using the Clip List Panel \(page 120\)](#)

CREATING CLIP LISTS FOR LOG AND CAPTURE

To encode and capture media clips from a VTR, follow these steps:

- 1. Create New Log & Capture Document.** If a Log & Capture document isn't open, select File > New Log & Capture to create a new, untitled Log & Capture document or open an existing Log & Capture document.

The Clip List panel, on the right, includes the General Tab for mark-in and mark-out points, metadata tabs, plus the clip list at the bottom. For details, see [Using the Clip List Panel \(page 120\)](#).

- 2. Select and Configure your Pipeline.** If you haven't already selected and configured Pipeline for this task, do so now. After configuring Pipeline for your workflow requirements, save the file. For details, see [\(Using The Pipeline Settings Panel \(page 64\)\)](#).

- 3. Preview your Media Stream.** When you connect, streaming media (if present) displays in the video panel. If you're connected to a VTR and it is in Remote mode, you can control your video using the VTR controls directly in Pipeline Control.

- 4. Create a Clip List.** Insert tapes in your VTR, then use the VTR controls to scrub media, create mark in and mark out points (General Tab), add metadata as necessary, then click the Log button to create the clip and add it to the list.

If you want to capture clips from multiple tapes, enter the name of the tape (or category) in the General > Tape field for the clip you're creating. Before capturing clips, select the tape (or category) from the clip list on the left, to display the clips you want to capture. You can use the tape name to filter your list. Alternatively, import an EDL to automatically create your clip list. (See [Loading and Saving Clip List Files \(page 81\)](#) for details.)

- 5. Capture the Clips.** Click the Activation slider (top right) to activate the document and capture the clips displayed in the clip list and save each one as a file. To capture clips from multiple tapes in one session, select All Tapes (Click the word *All*) before activating the document to capture your clips. You will be prompted to insert the correct tape when necessary and (if selected in preferences) the previous tape will be ejected.

USING THE LOG & CAPTURE DOCUMENT

The Log & Capture document is designed to facilitate logging and capturing clips.



Note

Generally, Log and Capture will be performed using a VTR controlled by an RS422 interface. However, as a convenience to our customers, the Pipeline Log and Capture interface allows clips to be logged and captured in workflows that are not being controlled using RS422. In these cases a warning is displayed indicating the lack of RS422 control. This allows the user to continue operation using manual control of the incoming signal.

Figure 8–1. Use the Log & Capture document to create clip lists and capture media from Pipeline.

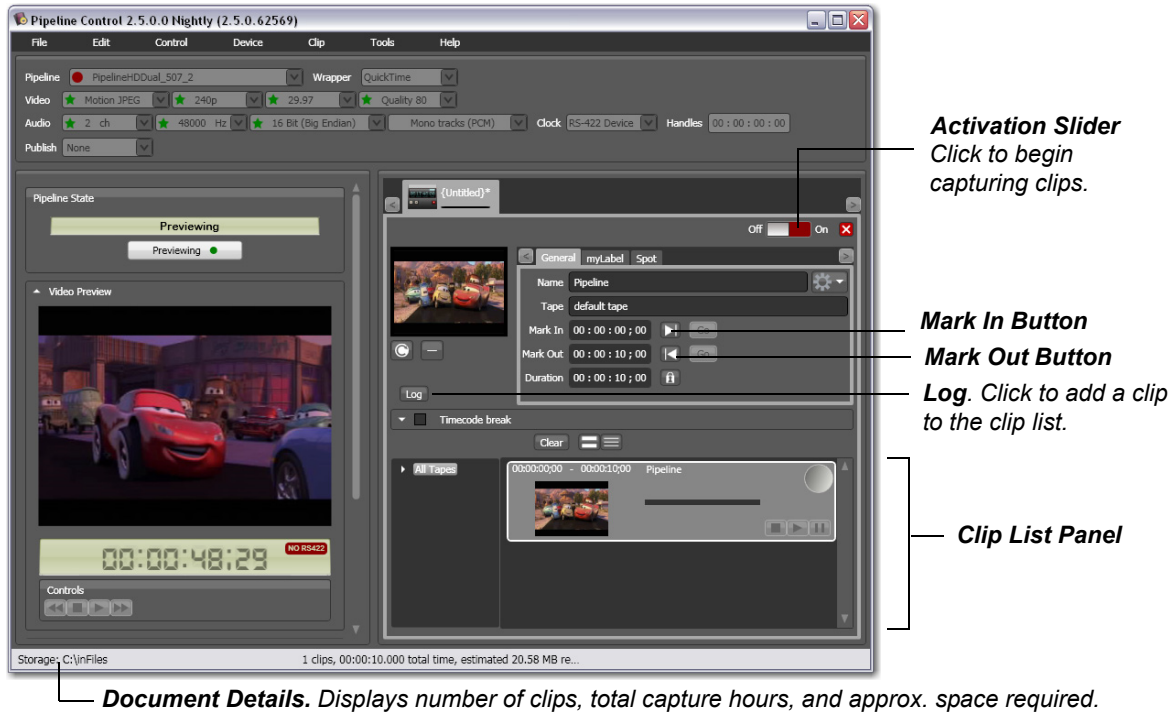

Pipeline Control displays several panels and toolbars to help you perform the tasks the document was designed to facilitate. Each panel, toolbar, and feature is described below.

For details on how to use the Pipeline Settings panel and all panels and controls on the left, see [Chapter 6, Using Pipeline Control \(page 57\)](#).

The log and capture document is composed of data entry tabs and a clip list (on the right), including tape names when logging clips from multiple tapes, with Pipeline State, Video Preview, Audio Preview, and Diagnostics panels on the left. You can open multiple document at a time – each is displayed in its own tab.

USING LOG & CAPTURE CONTROLS IN THE PREVIEW PANEL

In addition to the panels and controls described in ([Using The Video Preview Panel on page 79](#)), the Preview panel in Log & Capture window has additional controls to support log and capture activities.

Figure 8–2. Timecode, VTR, jog wheel & control status indicators in the Log & Capture window.



VTR Tape Status

Tape In. Displays when a tape is in the attached VTR.

Tape Out. Displays when a tape is not in the attached VTR.

Deck RS-422 Control Status

NO RS-422. Displays when Pipeline does not have control over the attached VTR.

RS-422. Displays when Pipeline has control over the attached VTR.

Alarm Status

ALARM. Displays when the deck has an outstanding alarm.

<blank>. Displays when there is no outstanding alarm.

USING THE CLIP LIST PANEL





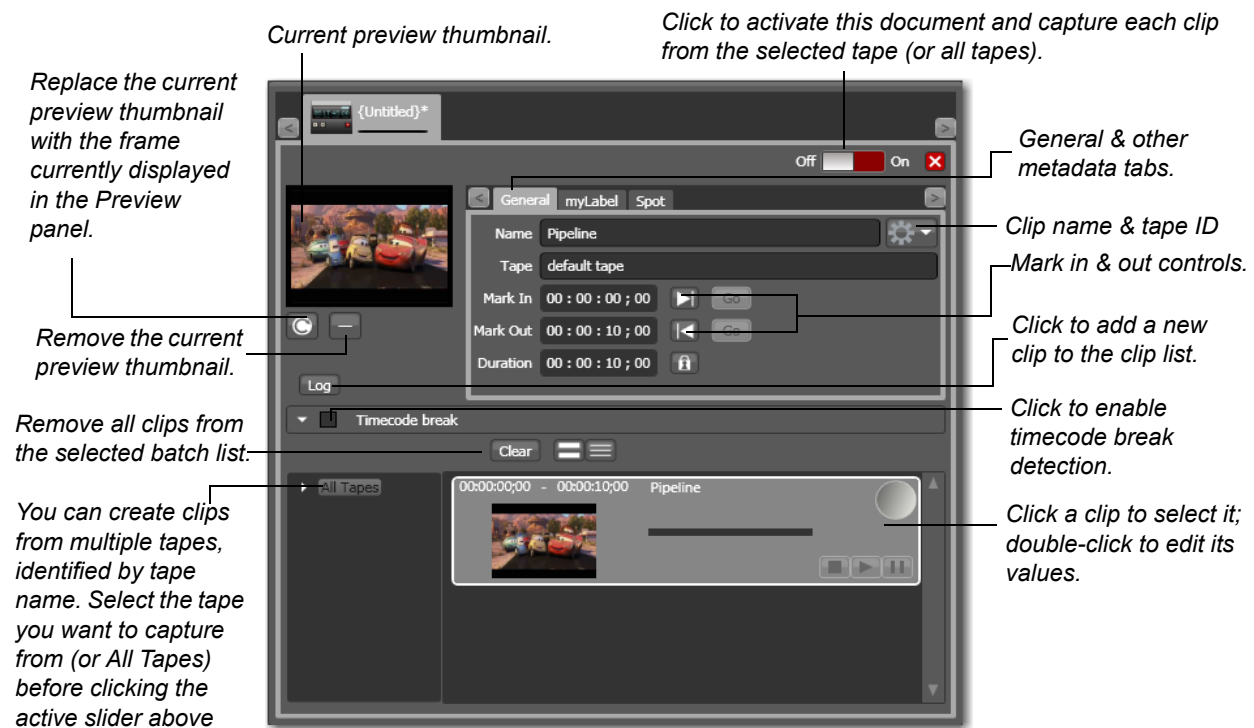



The Clip List panel displays on the bottom of the Log & Capture window – it includes the clip list. Each of the tabs holds metadata for the selected clip.

Figure 8–3. The Clip List panel allows you to work with and capture clips.





General Controls and Detail Fields



The following controls in the General tab perform certain functions or contain details about the clip:

Control	Description
	<p>Located at upper right, slide the activation slider to the right (to activate the document) when you're done creating or modifying your clip list. Activate your document to capture the clips for the selected tape or all tapes and save the files. Slide to the left to deactivate the document – stopping any capture in progress – when you want to edit the document or close it.</p> <p>Pipeline Control captures clips by controlling the VTR via the Pipeline to encode the clip and stream each clip's media to Pipeline Control, which writes the media out to a file, and saves each file in the destination folder.</p> <p>When the capture process completes, Pipeline Control disconnects from the Pipeline.</p>
	Located directly under the thumbnail frame, click to replace the current thumbnail frame with the frame currently displayed in the Video Preview panel.
	Located directly under the thumbnail frame, click to remove the current thumbnail frame.
	Located below the thumbnail frame, directly above the clip list, just right of the Clear button. Click to add the new clip to the clip list along with clip values and metadata. Make sure to use the correct tape name, if you're using multiple tapes.
	Located between Log and Clear buttons. Check to create a new clip (between Mark In and Mark Out times) for every timecode break found.
	Located below Timecode Break checkbox. Defines the number of missed frames required to constitute a timecode break, Range is 1 to 32 frames. Default is 1.
	Located below the thumbnail frame, directly above the clip list. Click to clear all clips from the selected tape.
	Located below the thumbnail frame, directly above the clip list. Click to switch between a clip view and a list view, depending on the task at hand.

Clip Status Badges

Each clip is marked with status badges to help you identify the state of each clip at a glance.

Status Badge	Description
	Pipeline Control attempted to capture the clip, but failed. This may be due to lack of storage, network or Pipeline problems, or excessive pre-roll at the beginning of a tape, for example. Resolve the problem and retry. Using the mouse, hover over the icon to display additional information.
	This clip is being closed. All media has been captured, but it has not been completely written to the file yet – possibly due to use of buffering.
	This clip has not been captured yet.

Status Badge	Description
	This clip is currently being opened/created, but no media has been captured yet.
	This clip is in the process of being captured.
	This clip has been successfully captured and the file has been closed.

General Tab Controls

Use the controls on the General tab to identify your clip, and set its in and out points.

Figure 8–4. Use the General tab to ID your clip/tape & set mark points.

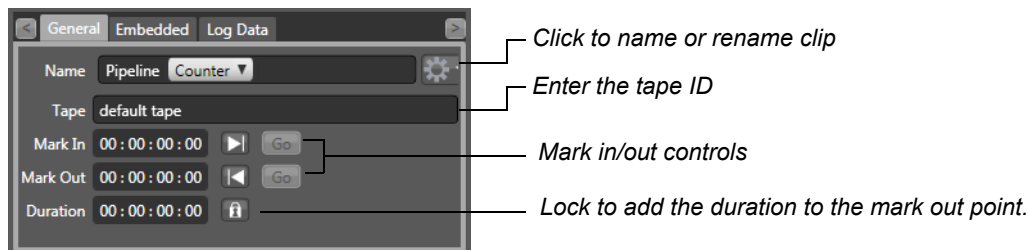

Name. In the Name field, enter a text phrase to name the root file name (not including the suffix). For additional files with the same root, Pipeline Control adds a unique number if you specify the counter token. File names are entered via the keyboard, but can also contain other parameters (date, codec, etc.) selected by using the pull-down menu provided

Tape. Enter the tape name to organize clips by tape, if you’re capturing from multiple tapes. These tape names display in the tree just to the left of the clips in the clip list. Tape names are not known by the deck or Pipeline Control, they are only used for human identification purposes.

Mark In. Click the arrow to update the Mark In point to the tape’s current timecode for the selected clip. Or, manually enter the timecode. To go to the point, click the Go button.

Mark Out. If you’re not using the duration, click to update the Mark Out point to the tape’s current timecode for the selected clip. Or, manually enter the timecode. To go to the point, click the Go button.

Duration. Click to disengage the lock (black). The duration is calculated as the end time minus the start time. While the lock button is disengaged (black), changes to the start timecode will cause the end timecode to remain the same, and the duration timecode to change. Any changes to the end timecode will similarly cause the start timecode to remain the same and the duration timecode to change.

Click again to engage the lock (blue). Duration always stays the same. When the lock button is engaged (blue), changes to the start or end timecode leave the duration timecode locked – as is. If you change the start timecode, the end timecode will adjust to match the new start time and the locked duration. If you change the end timecode, the start timecode will adjust to match the new end timecode and the locked duration.

For example, given a clip at 29.97 fps, if the duration is set to 00:00:30:00 with the In point at 01:00:00:00, the Out point will be 01:00:29:29. If the In point is changed to 01:00:10:00 the Out point will change to 01:00:39:29. Likewise, if the out point is changed from 01:00:39:29 to 01:00:49:29 the In point will change to 01:00:20:00.

A blue lock does not mean that the duration fields are locked (not editable). When the lock is blue, the duration value can be changed manually by entering a new duration in the duration fields.

Embedded Labels

Figure 8–5. Embedded Labels

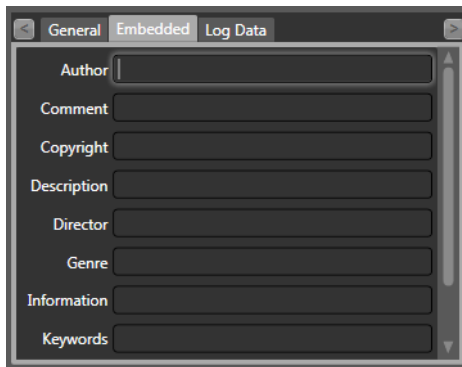

To view or update the label values for each clip event, click the embedded tab to display each metadata sheet. There may be more than one metadata label. Enter the labels you want to use. The Embedded label is always available; others (including FlipFactory labels, Final Cut Pro, and QuickTime) are dynamically generated as appropriate.

For Quicktime only, values in the Embedded label are embedded in the file that is created.

Editing Clip Details

Clips can be viewed in clip view or list view – click the Clip or List view button at the top of the list to switch views. Click a clip to select it. Double-click a clip to edit it in place.

Figure 8–6. Double-click to edit clip details in the General and Embedded tabs in place.

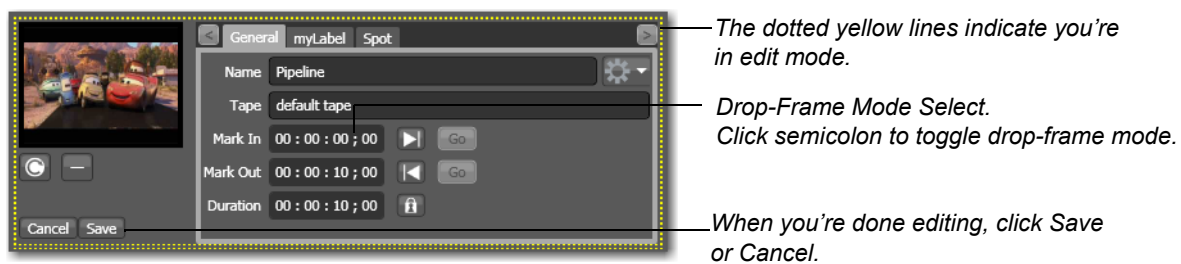

When you're done editing click Save to save your updates or Cancel to discard them and return to view-only.

Performing Other Clip Tasks

There are a variety of actions you can take on a selected clip, when you right-click on it:

Clear. Select to permanently remove the clip from the list. Files associated with the event are not deleted.

Edit. Select to display an editor dialog, so that you can modify the properties of the clip.

Show in Explorer. After the clip has been recorded, select to display the folder that contains the clip.

Recapture. After the clip has been recorded, select to re-capture the clip.

Using Clip View

In clip view (shown following), several controls are presented.

Figure 8–7. Use clip controls to review your clip.

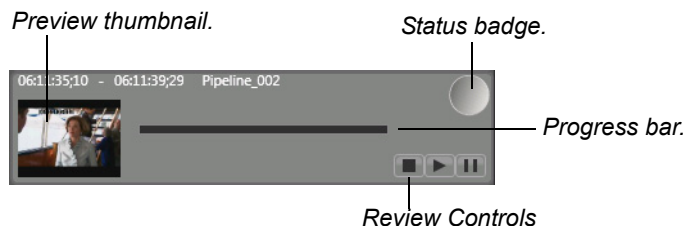

Preview Thumbnail. Assigned when you created the mark-in point.

Status Badge. Status badges to indicate the state of this clip.

Progress Bar. When capturing, colored yellow for captured and green for written to disk, indicating progress toward completion.

Review Controls. When file has been captured and closed, use these controls to view your clip locally.

Creating a Clip

To create a clip, insert your tape, make sure the Pipeline is connected, and follow these steps:

1. Click the General tab to display mark-in and mark-out controls.
2. Play/scrub the video using the VTR controls, then click the Mark In button to mark the start timecode (at right of Mark In code value field in the General tab of the Clip List panel).
3. Click the Mark Out button to mark the end timecode (at right of end timecode value field). When you have a start and end timecode value (and the start timecode is previous to the end timecode).
4. Optionally, enter a start timecode and a duration – the end timecode will be calculated for you.
5. Optionally, enter metadata on the any of the available metadata tabs.
6. Click Log to create the clip and add it to the list.

When not in edit mode, any data entry or edits you perform in any tab is for the next clip you may create.

Deleting a Clip

To delete a clip, select it from the clip list and press the Delete key or select Clip > Clear.



Note

This does not delete the clip if it has already been captured.

SETTING UP AND CAPTURING TIMECODE BREAK RECORDING

To set up timecode break recording, which is performed by timecode breaks in the video, insert the tape and make sure the Pipeline is configured and connected. After you've set up your configuration and logged your clips (details below), click Activate to initiate timecode break recording.

Generally these tapes have been recorded using time of day time code. Once activated the Timecode Break feature will create separate files when a break in the time code is detected. To accommodate for dropped frames when the tape was recorded, a Frame Threshold parameter is available.

Figure 8–8. Timecode Break Recording settings panel.

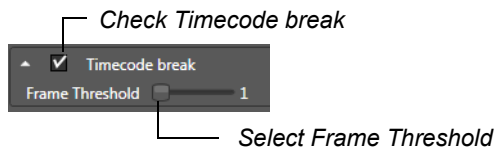

Timecode Break Checkbox. Check the Timecode Break checkbox to enable timecode break recording.

Frame Threshold. Defines how many discontinuous timecode frames required to constitute a break. Use the slide bar to set the frame threshold from 1 to 32. Default is 1.

Enter the minimum number of frames between time code breaks that will trigger a new clip to begin. For example if the Frame Threshold is set to '3' a new clip will be created when a break of 3 or more frames is detected. If a Time code breaks of less than '3' frames is detected it will be ignored and capturing will continue until a break of more than 3 frames is detected, the Max Duration is achieved for this clip, the end of tape is detected or the document is deactivated.

CHAPTER 9

Using Trigger Capture Documents

Pipeline Control's Trigger document enables you to manually or automatically record media in real time from a live source or VTR. You use the Trigger document to record media in real time from a VTR deck or live sources. You can perform the recording process in four ways: manually, automatically via Web services, by using timecode breaks, or under RS422 control.

You use the Web services by writing an application using the Pipeline Web Services API, in any supported SD or HD essence and file/wrapper format, directly from a Pipeline that is attached via Ethernet.



Note

When capturing media from Pipeline Quad, you can perform confidence monitoring to qualify your video. See [Confidence Monitoring \(page 51\)](#).

Topics

- [Using the Trigger Document \(page 128\)](#)
- [Using the Preview Panel \(page 130\)](#)
- [Setting up and Enabling Automatic Recording \(page 130\)](#)
- [Using CalDav Calendar \(page 131\)](#)
- [Manual & Timecode Break Recording \(page 134\)](#)
- [RS422 \(page 135\)](#)
- [Viewing and Updating Metadata Labels \(page 136\)](#)

USING THE TRIGGER DOCUMENT

The Trigger document is designed to facilitate manual and automatic clip recording. Pipeline Control can record files of any supported profile in any format/wrapper, up to 9 hours in length.

Figure 9–1. Use the Trigger window to capture video in real time.

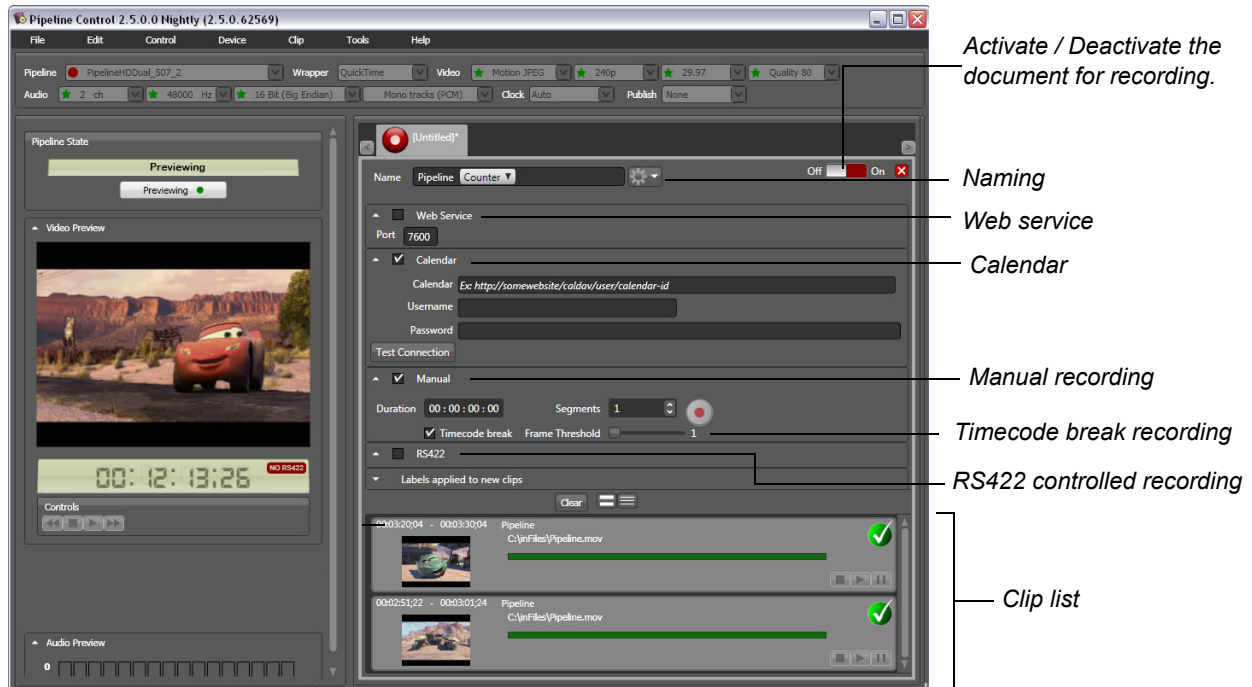

At the top of the window is the Pipeline Settings panel; on the left side is the Preview panel. For details on how to use the Pipeline Settings panel and the Preview panel, see [Chapter 6, Using Pipeline Control \(page 57\)](#). The right side of the window is the Clip panel which is designed to support crash recording and automation. The clip panel has settings to enable and configure automatic, calendar, manual, timecode-break, and RS422 controlled recording.

Pipeline Control will automatically reconnect a Trigger document if network connectivity or video signal is lost, but it will not continue processing future events. When your VTR is connected via RS-422 in remote mode, the VTR controls allow you to scrub media.

Naming Control

The naming control enables you to enter a text phrase to name the root file (not including the suffix). For additional files with the same root, Pipeline Control adds a unique number if the counter token is used. File names are entered via the keyboard, but can also contain other parameters (date, codec, etc.) using the pull-down menu provided.

The default name is automatically entered based on the parameters set in Preferences. To change the file name to be used, modify the basename and any token types desired. Token types can be Date, Time, Mark In (inclusive First Frame TC), Mark Out (exclusive Last Frame TC), Counter (increments by 1), Pipeline (name), Tape (name), Codec, Frame Rate, and External. The counter token ensures unique names.

Tokens are added by selecting them from the pull-down menu and are moved by clicking and dragging them to change their order in the filename.

The *External* token adds a name passed in by an external trigger source (from a CalDav Calendar or Web Service command, for example). The name used as a token is taken from the *START* command argument name. If no external name token is added to the Name field, the Event name will be ignored.

In the Web service trigger, the external token gets its value based on the value of the *name* parameter (if specified). In the calendar trigger, the external token gets its value based on the event name in the calendar (if specified). If these values are not specified, or if the capture is initiated with a trigger other than Web service or calendar, the external token is ignored.

Figure 9–2. Naming Control

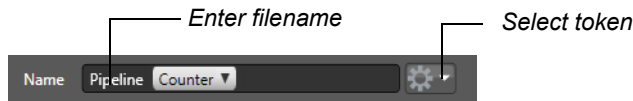







Note

Naming Tokens are applied when a clip is added to the clip list. The tokens Mark-In, Mark-Out, Date and Time are applied to the name based on the values known at the time they were added. If the start or end times are modified (through CalDav or the Web Service API), the new start and end values will not be reflected in the clip's name at the time of capture.

Clip Status Badges

Clip thumbnails are marked with status badges to help you identify the state of each clip at a glance.

Status Badge	Description
	Pipeline Control attempted to capture the clip, but failed. This may be due to lack of storage, network or Pipeline problems, or excessive pre-roll at the beginning of a tape, for example. Resolve the problem and retry. Using the mouse, hover over the icon to display additional information.
	This clip is being closed. All media has been captured, but it has not been completely written to the file yet – possibly due to use of buffering.
	This clip has not been captured yet.
	This clip is currently being opened/created, but no media has been captured yet.
	This clip is in the process of being captured.
	This clip has been successfully captured and the file has been closed.

USING THE PREVIEW PANEL

You can use the video and audio preview buttons to enable or disable audio and video preview from the video feed.

In addition to the panels and controls described in (Using The Video Preview Panel on page 79), the preview panel in the Trigger window has additional controls. If an optional VTR is attached, you can use the VTR controls to view VTR status, and in Remote mode, control it.

Figure 9–3. Jog and Shuttle in the Trigger window.



VTR Tape Status

Tape In. Displays when a tape is in the attached VTR.

Tape Out. Displays when a tape is not in the attached VTR.

Deck RS-422 Control Status

NO RS-422. Displays when Pipeline does not have control over the attached VTR.

RS-422. Displays when Pipeline has control over the attached VTR.

VTR Remote Status

LOCAL. Displays when VTR is in Local mode.

REMOTE. Displays when VTR is in Remote mode.

Alarm Status

ALARM. Displays when the deck has an outstanding alarm.

<blank>. Displays when there is no outstanding alarm.

SETTING UP AND ENABLING AUTOMATIC RECORDING

To set up automatic recording, which is performed by using Pipeline Web Services API requests from another application, check Web Service. Then, connect the feed or insert your tape, make sure the Pipeline is configured and connected. After you've set up your configuration (details below), click Activate to enable automatic recording.

For details on using the Web service, see Pipeline Web Service Application Note..



Note

If you want to use the Web Service in Pipeline, you must run the application with an administrator account because the Web Service requires elevated privileges.

Windows 7 Example:

1. Navigate to `\Program Files\Telestream\Pipeline Control`
2. Right-click `PipelineControl.exe`
3. Click the *Compatibility* tab
4. In the *Privilege Level* section, check *Run this program as an administrator*

Web Services and Port Number. Check Web services, and set the port number that the Web service should listen for incoming HTTP GET requests on. The port number value must be between 1025 and 49151, and the TCP port must be open on the host system and not blocked by a firewall.

Figure 9–4. Automatic Recording settings panel.

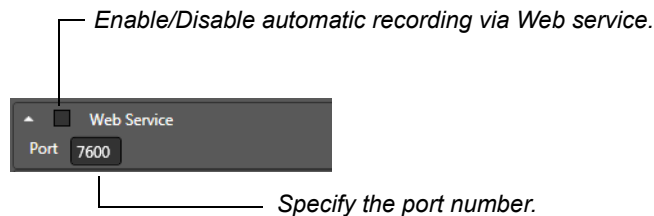

You can record all formats and file wrappers in this manner, depending on your Pipeline settings. All files have a 9 hour maximum clip length.

When the Web service is enabled and the Pipeline document is placed into an active state, the Web service begins listening for requests on the specified port. You are warned if the port is in use by another Trigger document or by some other service on the host computer.

USING CALDAV CALENDAR



Note

Scheduled capture events created by Repeat Event functionality of your calendar program are not fully supported by Pipeline Control's CalDav calendar trigger and should not be used. Instead, create events individually to ensure that all repeated events are captured.

The CalDav Calendar option enables you to record based on events on a CalDav compatible calendar (such as Google or iCal). The Pipeline Control software checks the calendar every ten seconds for changes in existing events and for new events then loads them into the Clip window within a two-hour look-ahead window of time. If a calendar event has been placed into the Pipeline Control's Clip window, then subsequently removed or changed, Pipeline Control will indicate the new state on the associate entry in the Clip window. If a calendar event has been deleted from the CalDav calendar, the clip entry will not be

removed from Pipeline Control's Clip window, but it will display a large X over the record icon. You can hover over the large X to view the tool reporting that the clip was removed before being captured.

Figure 9–5. Clip Window

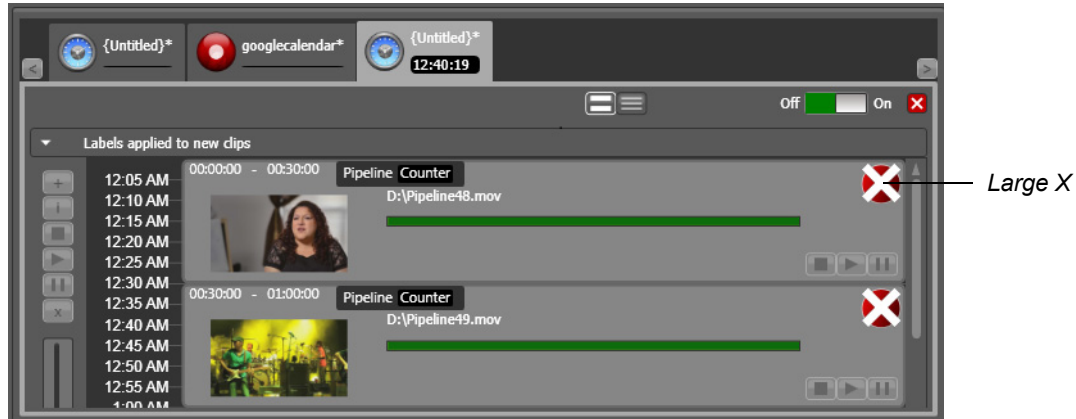

Note

The Calendar control requires a license. Without a license, the Calendar checkbox is greyed out and the message **Calendar Trigger is not Licensed** is displayed in red.

To use CalDav Calendar with Pipeline Control Trigger, follow these steps:

1. **Open a New Trigger Document.** If a Trigger document isn't open, select File > New Trigger Document to create a new, untitled Trigger document. Or, you can open a previously-saved document.
2. **Calendar checkbox.** Check the Calendar check box, then click the down arrow to display the calendar controls.

Figure 9–6. Calendar Controls.

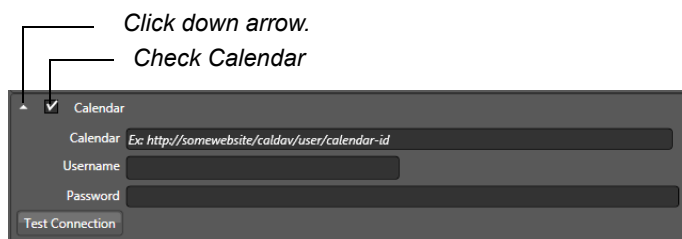

3. **CalDav URL.** In the Calendar field enter the URL to the CalDav calendar you want to use. Example: <https://www.google.com/calendar/dav/<your Google Calendar ID>/events/>.

Here are some examples:

- Google:
 - <https://www.google.com/calendar/dav/<calendarid>@group.calendar.google.com/events/>
 - <https://www.google.com/calendar/dav/1jk6tfqu7qqa0fihp2lthqju4o@group.calendar.google.com/events/>



Note

The Google Calendar URL must end with exactly all of these characters: /events/

- Bedework Personal Calendar:
 - `http://<IP or hostname>:<Port>/ucaldav/user/vbede/calendar`
 - `http://QA-RONT1:8080/ucaldav/user/vbede/calendar`
- Yahoo Calendar:
 - `http://caldav.calendar.yahoo.com/dav/teleststreamcalendar@yahoo.com/Calendar/teleststreamcalendar`



Note

Your Google Calendar ID for your primary calendar is your email address, but for all other calendars the Calendar ID is in the form of: <long string of characters> @group.calendar.google.com. You can get the Calendar ID by clicking the down arrow next to your calendar at calendar.google.com and selecting Calendar Settings.

Be sure to use “https” in your URL, because “http” will not work.

*When you are using the calendar trigger, make sure the **Use Duration as frame count instead of Mark Out point** checkbox (located near the bottom of the Tools > Options > Capture tab) is unchecked. This will enable events to be updated in Pipeline Control.*

Events can be scheduled directly on the CalDav calendar or by accepting event requests sent by external systems. If an event is requested and tentatively accepted with “Maybe”, the event will be captured as fully accepted.

CalDav calendar server applications may implement security restrictions to prevent unauthorized access. Set your calendar's security setting appropriately to allow Pipeline Control access to calendar events

- 4. Username.** In the Username field enter the email address you use with CalDav Calendar. This is the complete email address you use with CalDav Calendar, including the part after the @ sign. If you are using *Google Apps*, be sure to enter your Google Apps email address.
- 5. Password.** In the Password field enter is the password you use to sign in to Google Calendar.
- 6. Connect.** Click Test Connection. If the calendar URL, Username and Password are correct, then “Your settings are OK!” will display next to the Test Connection button. If an error message displays, go back and correct the URL, Username and Password, and reconnect.



Note

Pipeline does not support reoccurring events in Google Calendar. To do multiple events you must create a new separate event for each occurrence in Google Calendar

MANUAL & TIMECODE BREAK RECORDING

To manually record – encode and capture media – from Pipeline in real time, follow these steps:

- 1. Open a New Trigger Document.** If a Trigger document isn't open, select File > New Trigger Document to create a new, untitled Trigger document. Or, you can open a previously-saved document.
- 2. Select and Configure your Pipeline.** If you have not already done so, select and configure a Pipeline and save your configuration. For details, see [Using The Pipeline Settings Panel \(page 64\)](#).
- 3. Connect to the Pipeline.** When you connect, streaming media (if present) displays in the video panel. If you're connected to a VTR and it is in Remote mode, you can control your video using VTR controls.
- 4. Set up your live feed.** Connect your live feed or insert tapes in your VTR, then use the VTR controls to scrub the media to the starting point.
- 5. Enable Manual recording.** Check Manual to enable direct, user-control of this document. Specify the file name and enter a duration, then connect the live feed (or insert a tape).

Figure 9–7. Manual Recording settings panel.

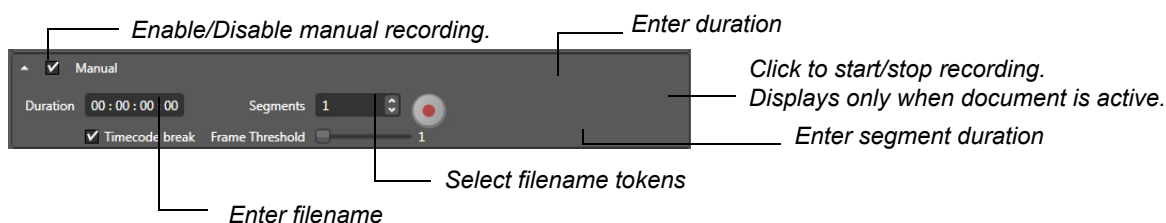

Duration. You can enter a duration for the amount of time Pipeline Control should record media to the file. Or, just click the Record button to stop recording when you choose. Default is 00:00:00:00 which creates a clip with a maximum duration of nine hours.

Segment. Optionally, you can enter a segmented duration which causes multiple clips to be captured during the full Duration time. If more than one segment is specified, the value specified in the duration field is divided by the number of segments. For example, a duration of sixty minutes with a segments value of 60, results in sixty one-minute clips. A duration of 60 minutes with a segments value of 2, results in two 30-minute clips. Default is 00:00:00:00, which disables segmented duration.



Note

When using the Segment value during capture, the last segment may be larger than any previous segment.

- 6. Capture the Video.** Click the Activate slider, then click the Record button to start recording. The recording will continue until the specified duration is reached or the capture is stopped manually by clicking the record button a second time. To use the Record button to start and stop recording, enter 0 in the Duration field. When recording using Open QuickTime, if you stop recording before the duration value is reached, the file will retain the original duration value.

WARNING: *During capture within a Trigger session depressing the '-' or '=' key will stop the capture immediately.*

When capture is complete, the file is closed.

To set up timecode break recording, which is performed by timecode breaks in the feed, make sure the Pipeline is configured and connected. After you've set up your configuration (details below), click Activate to enable timecode break recording.

Generally these feeds have been recorded using time of day time code. Once activated the Timecode Break feature will create separate files when a break in the time code is detected. To accommodate for dropped frames when the tape was recorded, a Frame Threshold parameter is available.

Figure 9–8. Timecode Break Recording



Duration. Duration is the maximum duration of any one individual clip. If the max duration is reached before a time code break is detected any clip being captured will stop. The system will continue in capture mode and will start a new clip at the next time code break. Duration default is 00:00:00:00, which allows for a maximum duration of nine hours. The duration control is inactive when the Record button is clicked.

Timecode Break Checkbox. Check the Timecode Break checkbox to enable timecode break recording.

Frame Threshold. Defines how many discontinuous timecode frames required to constitute a break. Use the slide bar to set the frame threshold from 1 to 32. Default is 1.

Enter the minimum number of frames between time code breaks that will trigger a new clip to begin. For example if the Frame Threshold is set to '3' a new clip will be created when a break of 3 or more frames is detected. If a Time code breaks of less than '3' frames is detected it will be ignored and capturing will continue until a break of more than 3 frames is detected, the Max Duration is achieved for this clip, the end of tape is detected or the document is deactivated.



Note

*A dropped or skipped frame will cause the capture session to stop. If you are capturing more than one segment and the capture session has stopped prematurely, some segments will not be captured. To prevent the capture session from being prematurely stopped by a lost or skipped frame, select the **Ignore lost frames** option from **Tools->Options->Capture** (see [Setting Up Pipeline Control Options on page 81](#)), or enable the firmware option **Ignore input discontinuities** on the Configure Panel (see [Using the Configure Panel on page 44](#)).*

RS422

Check RS422 to enable Pipeline system remote control for automation capability using a standard BVW (Sony 9-pin) connector. If the REC command (20.02) or the EDIT ON command (20.65) is received on the Pipeline's RS422 command, then a clip will be started. If the STOP command (20.00) is received on the Pipeline's RS422 command then a clip will be stopped. If a REC command is received while another RS422 capture is in progress, the previous capture will be stopped and a new one will begin.



Note

When using RS422 to control a Pipeline system, you must use an RS-422 cable (or adapter) that swaps the RS422 transmit and receive lines. Adapters are available from Telestream by contacting Technical Support (Part Number: 53-0024-00 RS-422).

VIEWING AND UPDATING METADATA LABELS

Figure 9–9. Labels Applied Panel.

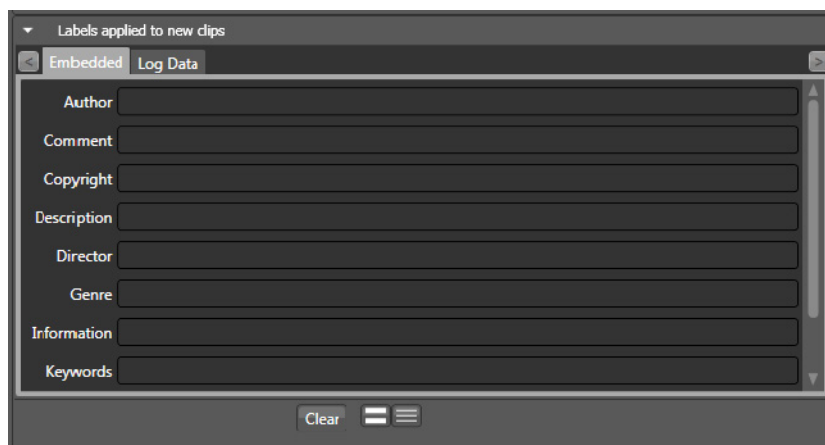

To view or update the label values for each clip event, click the embedded tab to display each metadata sheet. There may be more than one metadata label. The Embedded label is always available; others (including FlipFactory labels, Final Cut Pro, and QuickTime) are dynamically generated as appropriate. For Quicktime only, values in the Embedded label are embedded in the file that is created.

CHAPTER 10

Using Print to Tape Documents

Pipeline Control's Print to Tape document enables you to implement various types of print-to-tape operations from media files played out via Pipeline to your VTR. You can use the Print to Tape document to specify a set of clips and perform assembly and insert edits or crash print to tape.

Topics

- [Playout & Print to Tape Overview \(page 138\)](#)
- [Creating Print to Tape Documents \(page 139\)](#)
- [Using the Clip Panel \(page 140\)](#)

PLAYOUT & PRINT TO TAPE OVERVIEW

The Print to Tape document is designed to facilitate print to tape operations via Pipeline. You can set up the following print-to-tape operations:

- Assemble edits
- Insert edits
- Crash records.

Figure 10–1. Print to Tape window panels and toolbars.

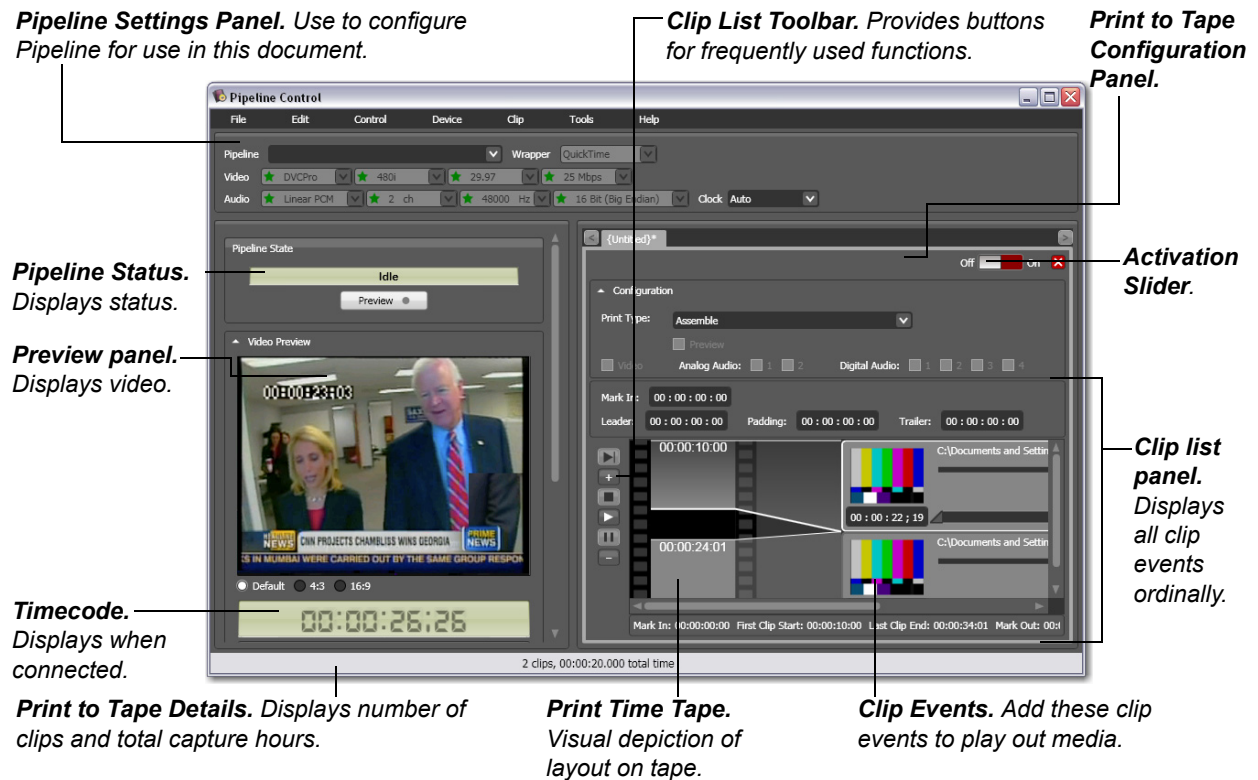

At the top of the window is the Pipeline Settings panel, and to the left is the Preview panel. For details on how to use these panels, see [Chapter 6, Using Pipeline Control \(page 57\)](#).

When your VTR (or VTR-enabled camera) is connected via RS-422 in remote mode, VTR controls below the Preview panel enable you to scrub the tape.

The Print to Tape document panel (bottom right) displays configuration settings and timecode settings. Below the timecode settings is the clip list, which displays a list of clips you have added.

Pipeline Control automatically reconnects a Print to Tape document if network connectivity or video signal is lost when you are previewing the tape, but it will not reconnect if the document has been activated.



Note

There are two ways to playout VANC data with a Pipeline system.

1. Track based VANC Data is obtained from the data tracks of the respective file formats. For QuickTime this includes the time code and closed caption tracks. For MXF OP1a this includes all data stored in the SMPTE 436M track data.

2. Video Essence based VANC Data plays out VANC data embedded into DVCProHD, ProRes, and DNxHD video essence frames. This method requires you to enable VANC essence playout option from the Pipeline Administration page. This option overrides Pipeline's track based playout. (See [Using the Configure Panel on page 44.](#))

(For more detail see: http://www.telestream.net/pdfs/app-notes/app_Pipeline_VBI-VANC_Support.pdf).

CREATING PRINT TO TAPE DOCUMENTS

A *Print to Tape* document contains one or more clip file events in QuickTime (mov) or OP-1a MXF format, which you use to play out SDI video from Pipeline in real time. The video format is automatically detected, and decoded by the appropriate codec in the Pipeline, and played out under control of Pipeline Control.

Here are the steps you'll take to create and use a Print to Tape document:

1. **Open a New Print to Tape document.** If a Print to Tape document isn't open, select File > New Print to Tape Document to display a new, untitled Print to Tape document window.

Or, you can open a previously-saved document.

2. **Select your Pipeline.** If you haven't already selected your Pipeline for this workflow, do so now. After configuring Pipeline for your workflow requirements, save the file. For details, see [Using The Pipeline Settings Panel \(page 64\)](#).

3. **Select insert, assemble, or crash print type.** *Insert* allows the replacement of video and/or audio. *Assemble* takes the entire video/audio stream for a given amount of time. *Crash* starts the deck in record mode and writes everything to tape. It is not guaranteed to be frame accurate. Only *Insert* allows the video and audio operation to be configured.

4. **Select the type of operation you want.** If Insert print type has been selected, configure your Print to Tape operation by checking the Preview, Video, and Audio check boxes as desired.

Figure 10–2. Print to Tape configuration panel.



Preview. When Preview is selected the Pipeline Control software will put your VTR into its Preview mode. This allows you to review your edit via the VTR's preview mode prior to committing it to tape.

Video. Check to play out video (available in Insert edit mode only).

Analog Audio. Check audio flag 1 and/or 2 to route audio channels based on the deck configuration. (Available in Insert edit mode only).

Digital Audio. Check audio flag 1 and/or 2 to play out these channels (available in Insert edit mode only).

5. Set timecode values. Set timecode values for Mark In, Leader, Padding, and Trailer as desired.

Figure 10–3. Print to Tape Timecode panel.

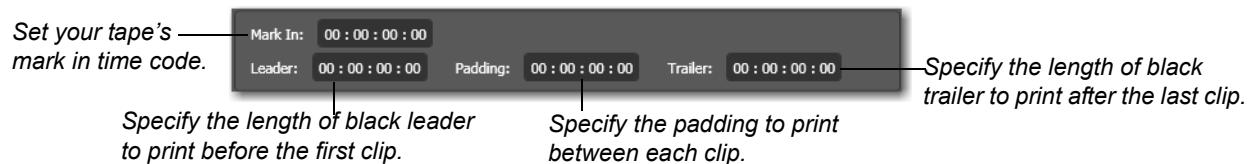

Mark In. Enter the timecode of the first frame on the tape where media will begin to be laid down.

Leader. Enter the length of black leader to play out before the first clip.

Padding. Enter the length of space to leave between clips as they are played out.

Trailer. Enter the length of black trailer to play out at the end of the last clip.

6. Add your Clips. Using the Clip panel, add your files to the list, trimming each file as appropriate. You can only add QuickTime and OP-1a MXF movies that conform to the requirements of the Print to Tape document, and all clips must have the same essence. For details, see (Using the Clip Panel (page 140)).

7. Play Out the Video as Print to Tape. Click the Activate slider to start playing out your clips.

USING THE CLIP PANEL

The clip panel (on bottom, right side of the window) allows you to specify a set of clip files to play out in a print to tape operation, view a virtual tape track, and adjust trim points on each clip (clip markers).

Figure 10–4. The clip panel allows you to create a collection of clip files to print to tape.

Tape Stripe. Visual track for each leader, clip, and padding, by timecode.

Clips. Drag QuickTime mov files or click + to add them to the list. Click and drag to rearrange.

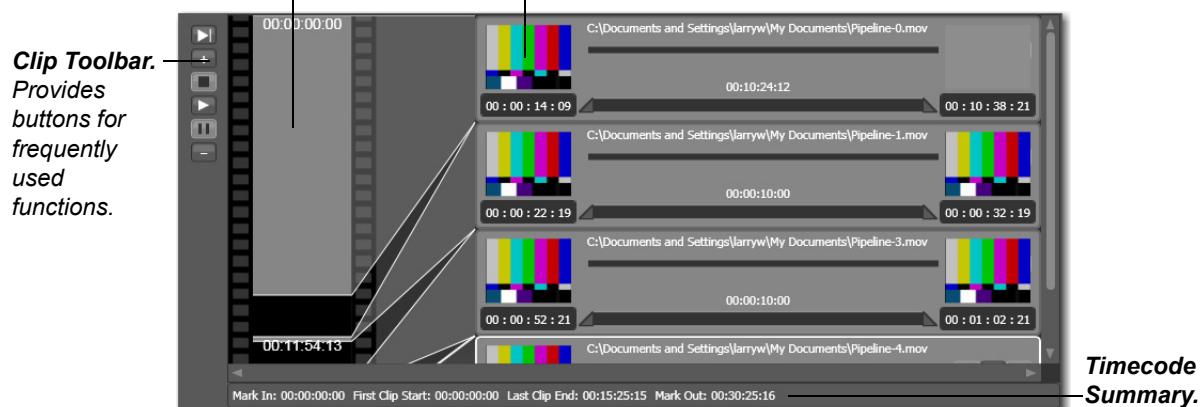

At the bottom of the clip list is the document's time code summary. The timecode summary includes Mark In – (start of leader or first clip), First Clip Start, Last Clip End, and Mark Out. By convention, the terms Mark In and Mark Out are inclusive-exclusive. Thus, Mark Out is the time code of the first frame NOT recorded. Clip start and clip end times are inclusive-inclusive.

Adding, Organizing, and Deleting Clips

To add a clip, drag an OP-1a MXF or QuickTime movie file (containing media essences supported by Pipeline) onto the clip space. You can only drag one clip file at a time using this method. Or, click + (Plus icon) in the toolbar to display a File System dialog. Navigate and select files to add to the clip list.

To delete a clip, select it in the clip list and press Delete or click the - (Minus icon) in the toolbar.

To rearrange clips, click and drag them to the position you want them in.



Note

Files used for Playout must contain identical number of audio channels and the same bit depth/type.

Clip Panel Toolbar

At the far left is a toolbar with buttons for frequently used functions.

Figure 10–5. The Clip Panel toolbar displays icons for frequently used commands.

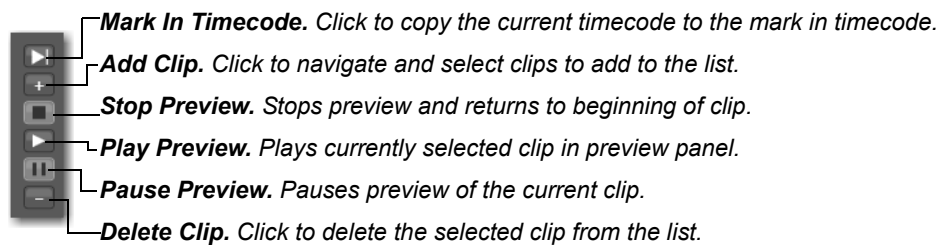

Print Time Tape

To the right of the toolbar is the Print Time Tape. The Print Time Tape is a virtual representation of the order and time the leaders, padding, trailer, and clips will be applied to the tape.

Figure 10–6. Print Time Tape details.

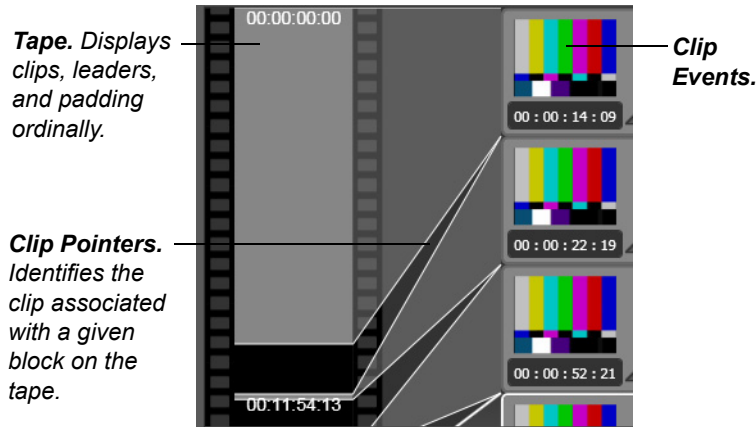

The print time tape helps you visualize how the clips will be printed, and includes leader, trailer and padding so that you can visualize and confirm the result of the print to tape operation before you actually perform it.

Figure 10–7. Print Time tape during playback.

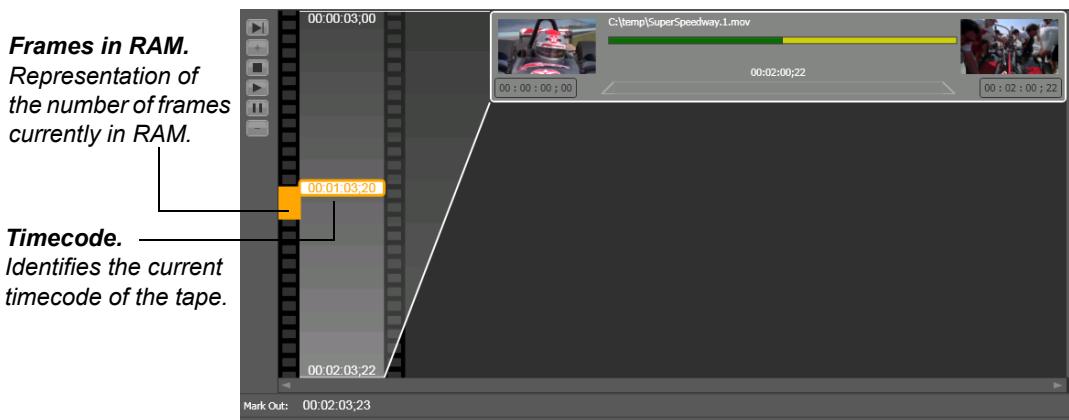

During a print to tape operation, the current timecode of the tape displays, along with a bar indicating the relative number of frames held in RAM. Additionally, the clip being printed displays a progress bar.

Clip Events

Each clip file you add to the clip list is identified by a clip event.

Figure 10–8. Clip events in your schedule provide details about the clip.

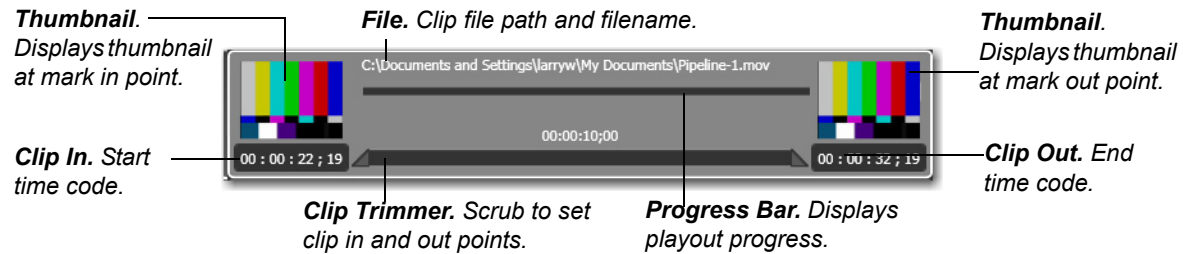

Each clip event has several controls:

Preview Thumbnails. Displays previews of the mark-in and mark-out frames.

File Path. Displays the full path and file name of the clip for this clip event.

Duration. Specifies the duration of playout, as calculated by the clip in and clip out points.

Clip In & Clip Out. Set by using the scrubber controls to adjust clip in and clip out points.

Trimmer. Use the scrubber controls at the left and right to set your clip in and clip out points.

Progress Bar. When a file is playing out, displays relative progress and amount of media frames currently held in RAM.

CHAPTER 11

Using Controlled Playout Documents

Pipeline Control's Controlled Playout document enables you to assemble a sequence of media files and play them out in a controlled fashion. Controlled Playout, when activated, acts as a virtual tape deck that provides play, stop, pause, rewind, fast forward, jog and shuttle controls. External control using JLCooper MCS2 USB controller, standard RS422 (Sony 9-pin/BVW) controllers, or Pipeline Web Service is also provided.



Note

The Controlled Playout doc requires v2.5 or later firmware

Topics

- [Controlled Playout Overview \(page 146\)](#)
- [Creating Controlled Playout Documents \(page 147\)](#)
- [Using the Clip Panel \(page 149\)](#)

CONTROLLED PLAYOUT OVERVIEW

The Controlled Playout document is designed to provide a method to play out media via Pipeline's SDI output with standard deck controls:

Figure 11–1. Controlled Playout window panels and toolbars.

Pipeline Settings Panel. Use to configure Pipeline for use in this schedule.

Controlled Playout Configuration Panel.

Pipeline Status.
Displays status.

Preview panel.
Displays video.

Timecode.
Displays when connected.

Activation Slider.

Clip list panel.
Displays all clip events ordinarily.

Controlled Playout Details. Displays storage location, number of clips, total capture hours, and approx. space required.

Clip List Toolbar. Provides buttons for frequently used functions.



At the top of the window is the Pipeline Settings panel, and to the left is the Preview panel. For details on how to use these panels, see [Chapter 6, Using Pipeline Control \(page 57\)](#).

The Controlled Playout document panel (bottom right) displays configuration settings. Below these settings is the clip list, which displays a list of clips you have added.

Pipeline Control will automatically reconnect a Controlled Playout document if network connectivity is lost while in the preview state (Pipeline State displays *Previewing*). However, if the document has been activated into a play out state (Pipeline State displays *Playing Out*) and network connectivity is lost, you must manually re-activate the document.



Note

There are two ways to playback VANC data with a Pipeline system.

1. Track based VANC Data is obtained from the data tracks of the respective file formats. For QuickTime this includes the time code and closed caption tracks. For MXF OP1a this includes all data stored in the SMPTE 436M track data.

2. Video Essence based VANC Data plays out VANC data embedded into DVCProHD, ProRes, and DNxHD video essence frames. This method requires you to enable VANC essence playback option from the Pipeline Administration page. This option overrides Pipeline’s track based playback. (See [Using the Configure Panel on page 44.](#))

(For more detail see: http://www.telestream.net/pdfs/app-notes/app_Pipeline_VBI-VANC_Support.pdf).

CREATING CONTROLLED PLAYOUT DOCUMENTS

A Controlled Playback document contains one or more clip file events in QuickTime (mov) or OP-1a MXF format, which you use to play out SDI video from Pipeline in real time. The video format is automatically detected, and decoded by the appropriate codec in the Pipeline, and is played out under control of Pipeline Control.

Here are the steps you’ll take to create and use a Controlled Playback document:

- 1. Open a New Controlled Playback document.** Select File > New Controlled Playback Document to display a new, untitled document window. (You can also open a previously-saved document by selecting File > Open.)
- 2. Select your Pipeline.** If you haven’t already selected your Pipeline for this workflow, do so now. After configuring Pipeline Control for your workflow requirements, save the file. For details, see [Using The Pipeline Settings Panel \(page 64\).](#)
- 3. Enable Web service.** If Pipeline Web service is used, check the Web Service checkbox and enter the port number to be used in the Port field. (See Web Service application note for API details):

Figure 11–2. Web services configuration panel.



- 4. Enable manual control.** Check Manual checkbox to enable manual control and click Jog/Shuttle button to select mode:

Figure 11–3. Manual control configuration panel.



The Controlled Playback document can be controlled from an external JL Cooper MSC2 USB controller. This device provides Play, Stop, FWD, Rewind, Jog and Shuttle controls. All necessary drivers are

installed when Pipeline Control is installed on your workstation. Simply plug the device into any available USB port on your workstation.

If you have a Pipeline Controlled Playout document open when the JL Cooper MSC2 USB controller is connected, you will see this image appear:



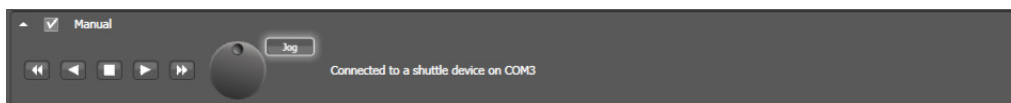

When a JL Cooper MSC2 USB controller is installed, *Connected to a shuttle device on COMx* is displayed in the Manual control user interface:



5. Enable remote control automation. Check the RS422 checkbox to enable remote control via the RS422 port. This functionality allows for external control using an RS422 playout controller:



If playout is being controlled via an automation system that utilizes the full set of *Sony 9-pin BVW commands through RS422*, the following restrictions apply:

- Only a single clip can be loaded into the clip list. Adding more than one clip into the clip list can cause an error when an automation command attempts to pre-roll to a time code prior to the first frame time code of the clip to be played out.
- Playout Mode must be set to *Play out all clips*. 
- Clip Transition Mode must be set to *Continue playout after each clip*. 



Note

When using RS422 to control a Pipeline system in the Controlled Playout mode, you must use an RS-422 cable (or adapter) that swaps the RS422 transmit and receive lines. Adapters are available from Telestream by contacting Technical Support (Part Number: 53-0024-00 RS-422).

- 6. Add your Clips.** Using the Clip panel, add your files to the list, trimming each file as appropriate. You can only add QuickTime or MXF OP1a files that conform to the requirements of the Controlled Playout document, and all clips must have the same essence. For details, see [Using the Clip Panel \(page 149\)](#).
- 7. Play Out the Video as a virtual Tape deck.** Click the Activate slider to activate the Controlled Playout document. For manual Control use playout controls and the jog/shuttle wheel to control the play out. Use an RS-422 controller or the Pipeline Web Service commands to play out clips from an external source.

USING THE CLIP PANEL

The clip panel (on bottom, right side of the window) allows you to specify a set of clip files to view as tracks, adjust trim points on each clip (clip markers), and play out in a virtual tape deck operation.

Figure 11–4. The clip panel allows you to create a collection of clip files to play out.

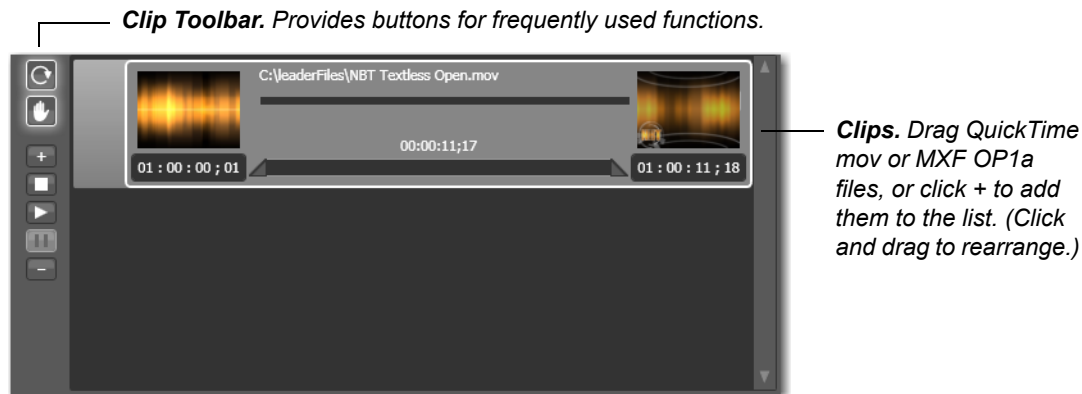

Adding, Organizing, and Deleting Clips

To add a clip, drag a QuickTime or MXF OP1a file (containing media essences supported by Pipeline) onto the clip space. You can only drag one clip file at a time using this method. Or, click + (Plus icon) in the toolbar to display a File System dialog. Navigate and select files to add to the clip list.

To delete a clip, select it in the clip list and press Delete, or click the - (Minus icon) in the toolbar.

To rearrange clips, click and drag them to the position where you want them.



Note

Files used for Payout must contain identical number of audio channels and the same bit depth/type.

Clip Panel Toolbar

At the far left is a toolbar with buttons for frequently used functions.

Figure 11–5. The Clip Panel toolbar displays icons for frequently used commands.

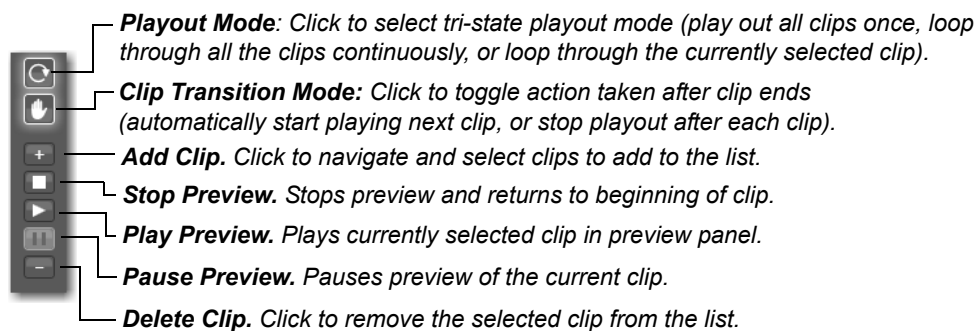

Clip Events

Each clip file you add to the clip list is identified by a clip event.

Figure 11–6. Clip events in your document provide details about the clip.

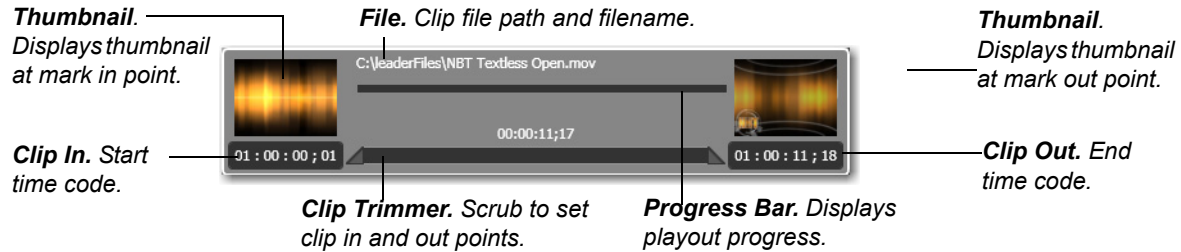

Each clip event has several controls:

Preview Thumbnails. Displays previews of the mark-in and mark-out frames.

File Path. Displays the full path and file name of the clip for this clip event.

Duration. Specifies the duration of playout, as calculated by the clip in and clip out points.

Clip In & Clip Out. Set by using the scrubber controls to adjust clip in and clip out points.

Trimmer. Use the scrubber controls at the left and right to set your clip in and clip out points.

Progress Bar. When a file is playing out, displays relative progress and amount of media frames currently held in RAM.

APPENDIX A

Troubleshooting

This appendix provides instructions for gathering information to assist in troubleshooting. For a complete and current list of potential issues and recommendations, go to http://www.telestream.net/download-files/pipeline/guides/Pipeline_FAQ.pdf

This information may be useful to Telestream Customer Service when you're obtaining support ([Obtaining Pipeline Support | Information | Assistance \(page i\)](#)).

GATHERING INFORMATION FOR TROUBLESHOOTING

These topics enable you to gather various details that aid in troubleshooting, depending on your workflow and environment.

- [Workflow Information](#) (immediately following)
- [Pipeline Device Firmware Information \(page 153\)](#)
- [Pipeline Administrator Counters Panel Details \(page 153\)](#)
- [Obtaining Debug Logs from Pipeline Control \(page 153\)](#)

Workflow Information

First, briefly document the workflow and obtain system information about your source and/or destination system: FlipFactory (immediately following), Episode Engine ([Page 152](#)), Pipeline Control for Mac OS X ([Page 152](#)), Pipeline Control for Windows ([Page 152](#)), or Final Cut Pro ([Page 153](#)).

FlipFactory

Obtain FlipFactory information using FlipFactory's automatic support email or obtain it manually.

To obtain the information automatically, send email to Telestream by using the Email Tech Support button on the FlipFactory System Settings window (see the FlipFactory User's Guide, Chapter 5, Using FlipFactory, in the Sending Email to Tech Support section).

To obtain this information manually:

- Get FlipFactory version and all update packs which are installed
- Get a copy of the FlipFactory license file
- Get account and factory details – obtain an XML output of the account when possible
- Obtain the FlipFactory server and/or Pipeline client system information:

1. Click Start > Help and Support.
2. On the Help and Support panel, click Support from the top menu.
3. Click Advanced System Information.
4. Click View detailed system information.
5. On the System Information dialog, select File > Save to save an nfo file containing your system information to the desktop of the computer.

Episode Engine

Obtain the Episode Engine version and export your compression template to a file.

Obtain the Mac OS X system profile:

1. Launch the System Profiler, which is located at: /Applications/Utilities/System Profiler.
2. Select Save As... from the File menu.
3. Select Rich Text Format (RTF) from the Format popup menu.
4. Save the file to the desktop.

Pipeline Control for Mac OS X

Obtain the Pipeline Control for Mac OS X version and the Pipeline device firmware version ([Pipeline Device Firmware Information \(page 153\)](#)).

Obtain the Mac OS X system profile:

1. Launch the System Profiler, which is located at: /Applications/Utilities/System Profiler.
2. Select Save As... from the File menu.
3. Select Rich Text Format (RTF) from the Format popup menu.
4. Save the file to the desktop.

Save the Pipeline document(s) containing all of your settings, and send the system profile document and all Pipeline documents to Telestream support with other debug information.

If you are using a FlipFactory or Episode Engine publisher, obtain all of the system information associated with these systems ([FlipFactory \(page 151\)](#) and [Episode Engine \(page 152\)](#)).

Pipeline Control for Windows

Obtain the Pipeline Control for Windows version and the Pipeline device firmware version ([Pipeline Device Firmware Information \(page 153\)](#)).

Obtain the Windows system information profile:

1. Run the System Information tool: Start > All Programs > Accessories > System Tools > System Information.
2. Select Export from the File menu.
3. Save the System Information file to the desktop.

Save the Pipeline document(s) containing your settings and send the system profile document and Pipeline documents to Telestream support with other debug information.

If you are using a FlipFactory publisher, obtain all of the system information associated with these systems ([FlipFactory \(page 151\)](#)).

Final Cut Pro

Obtain the Final Cut Pro version and Pipeline plug-in revision.

Obtain the Mac OS X system profile:

1. Launch the System Profiler, which is located at: /Applications/Utilities/System Profiler
2. Select Save As... from the File menu.
3. Select Rich Text Format (RTF) from the Format popup menu.
4. Save the file to the desktop.

Pipeline Device Firmware Information

Obtain the Pipeline's firmware revision number. Locate the Main and App Loader revision numbers on the Configure panel of Pipeline Administrator ([Using the Configure Panel \(page 44\)](#)).

Obtain Network Details

Pipeline IP address – default, static or DHCP (F/W v2.4 or earlier).

Document whether the connection is direct or through a switch.

If the connection is through a switch, is the route through more than one?

Are there any managed switches between the Pipeline and the target system?

What is the speed of each leg of the connection: 100Mb or 1000Mb (Gigabit).

Document whether the LAN is used for general data traffic and video traffic or only video traffic.

Pipeline Administrator Counters Panel Details

If a video or audio issue is being reported, repeat the encode or playout process while running Pipeline Administrator and viewing the counters on the Counters panel (see [Using the Counters Panel \(page 53\)](#) for a description of these parameters). To display the Counters panel, click counters in Pipeline Administrator's menu.

Obtaining Debug Logs from Pipeline Control

Debugging Pipeline components (hardware, client applications, etc.) can rarely be done independently. Since they all work as a system, they must be debugged as a system. The information obtained through these techniques can point to a problem anywhere in the system, and even to problems in multiple points in the system.

Mac OS X

Debug logs for Pipeline Control are generated only when you enable them, by editing property list files:

- Net.telestream.system.plist
- Net.telestream.PipelineControl.plist
- Net.telestream.tifo.plist
- Net.telestream.dvcprohd.plist
- Net.telestream.imx.plist

Each of these files controls, among other things, the output of debug information for different subsystems. The system plist handles enabling and disabling debug logging for the Pipeline Engine, the lowest layer of the Pipeline software suite. The second plist, *PipelineControl*, handles application level logging – the Pipeline Control application itself. The media format plists (tifo, devprohd, and imx, for example), handle debug logging for various QuickTime decompressor components.

To enable debug logging, first exit Pipeline Control. If you want to obtain debug logging for QuickTime decompressors, then you'll need to also exit QuickTime-enabled applications including QuickTime Player or Final Cut Pro.

Now, add a *DebugLevel* key to the plist as a number (for example, *NSNumber*), and a value 5. Save the changes to the plist and start PipelineControl again. Optionally, you can add a *DebugLog* key as a string (for example, *NSString*) to the plist, with a complete absolute path to a target text file. This causes debug logging to be output to the target text file instead of to the default location, which is viewable by the Console application.

To view the logs, you can open the Console application (located in Applications/Utilities) and select the log from the panel on the left. This panel may need to be opened first – click the Show Log List icon in the upper left. After selecting the desired log file in the list, select File > Save As to save a copy to send to Customer Service.

Windows

Pipeline Control for Windows saves details in trace (...trace.log) files, located at:

Win7: C:\Users\

When requested, E-mail the latest log file, along with other details, to Customer Service.

APPENDIX B

Pipeline EDL Syntax

This appendix provides information about the proper syntax for the content of Pipeline EDL documents.

PIPELINE EDL SYNTAX REQUIREMENTS

Pipeline EDL files contain an entry for each clip to be captured. Each entry consists of a single-line event, a clip name field, and optional Telestream specific metadata fields. Columns are significant.



Note

Line endings for a Pipeline EDL file must be CRLF (Carriage Return followed by Line Feed), which is the DOS/Windows standard. Therefore, if you create an EDL file from scratch on a Macintosh, you may have to convert the line endings.

Event Line Fields

Pipeline EDL files contain an entry for each clip to be captured. Each entry consisting of a single-line event, a clip name field and optional Telestream specific metadata fields.

Event Line Form

```
1111 222222 333333 4444 555 666666666666 777777777777 888888888888 999999999999
```

Event Parameters

1111 = Column 1, 4-digit event number 0001 to 9999

222222 = Column 6, six character alphanumeric tape name (can be overridden by optional TAPENAME)

333333 = Column 13, six characters, leading with an A (audio) or V (video)

4444 = Column 20, must always be "C " (C followed by three spaces)

555 = Column 25, Must always be " ", three spaces

666666666666 = Column 29, SMPTE timecode of source Mark-In (hh:mm:ss:ff)

777777777777 = Column 41, SMPTE timecode of source Mark-Out

888888888888 = Column 53, not used

9999999999 = Column 65, not used.



Note

Each parameter (1 through 9) must be separated by a single space.

Example: 0001 Reel01 A12V C 00:00:38;22 00:00:41;14 00:00:38;22 00:00:41;14

Clip Name Field (optional)

*CLIP: <Name_of_the_clip>

This name will be used by FlipFactory as the file name.

Begin Additional Fields Parameter

Telestream metadata fields (optional):

*TELESTREAM_METADATA: BEGIN

If optional TELESTREAM fields are included, the BEGIN parameter is required to be first.

Pipeline

This parameter determines which Pipeline to connect to for this clip entry. The name used for this field is the Bonjour friendly name assigned to the Pipeline device. This name defaults to Pipeline_XXXX where XXXX is the Pipeline's serial number.

The friendly name can be obtained by issuing the config CGI GET command to the Pipeline. The friendly name is contained within the Identity element of the returned XML descriptor. Config command example: <http://<Pipeline IP Address>/command.cgi?config>.

*TELESTREAM_METADATA: PIPELINE <Pipeline service name>

Example: *TELESTREAM_METADATA: PIPELINE Pipeline_3005

Pre-roll Value to VTR

*TELESTREAM_METADATA: PREROLL <Numeric value in seconds>

Example: *TELESTREAM_METADATA: PREROLL 2

Offset for Frame Accuracy

*TELESTREAM_METADATA: OFFSET <Numeric value in frames>

Example: *TELESTREAM_METADATA: OFFSET 0

Anamorphic Flag

Produced when video is specified as 16 x 9 format because the 16 x 9 check box has been selected on the live page for proper video display. Any EDL produced with this option checked will also set the ANAMORPHIC flag to TRUE:

*TELESTREAM_METADATA: ANAMORPHIC TRUE

This flag insures that anamorphic flags are set in appropriate output files in FlipFactory.

Abort Switch for Dropped Frames

A *true* value will abort the process if a frame is dropped, *false* will continue even if a frame is dropped

*TELESTREAM_METADATA: ABORT <true/false>

Example: *TELESTREAM_METADATA: ABORT false

Name of Tape

*TELESTREAM_METADATA: TAPENAME <Alphanumeric>

Example: *TELESTREAM_METADATA: TAPENAME TAPE1234

Description of Clip

*TELESTREAM_METADATA: DESCRIPTION <Alphanumeric>

Example: *TELESTREAM_METADATA: DESCRIPTION This is a test

Scene Number or Name

*TELESTREAM_METADATA: SCENE <Alphanumeric>

Example: *TELESTREAM_METADATA: SCENE Good cop bad cop

Take Number

*TELESTREAM_METADATA: TAKE <Numeric>

Example: *TELESTREAM_METADATA: TAKE 2

Additional Notes

*TELESTREAM_METADATA: NOTES <Alphanumeric>

Example: *TELESTREAM_METADATA: NOTES Additional information goes here.

End of Additional Fields Parameter

*TELESTREAM_METADATA: END

If optional TELESTREAM fields are included this parameter is require to be last.

APPENDIX C

Pipeline Control Codec Profiles

This appendix describes each Pipeline codec's preset profiles. SD profiles are available in Pipeline SC and Pipeline Quad. Both SD and HD codec profiles are available in Pipeline HD Dual.

Some wrapper/file formats do not support all possible audio / video options. For example, MXF wrappers (Avid, XDCam, and Op1a) do not support 16 channels of audio.

Video Profiles

- [DNxHD Profiles \(page 160\)](#)
- [DV and DVCPro Profiles \(page 160\)](#)
- [DVCPro HD Profiles \(page 160\)](#)
- [Avid IMX Profiles \(page 161\)](#)
- [ProRes Profiles \(page 161\)](#)
- [Motion JPEG Profiles \(page 161\)](#)
- [SD Uncompressed Profiles \(page 162\)](#)

Audio Profiles

- [Linear PCM Profiles \(page 162\)](#)

DNxHD Profiles

Table C–1. DNxHD Profiles

Vertical	Horizontal	Aspect Ratios	Frame Rates	Quality
720p	1280	16:9	23.976, 25, 29.97, 50, 59.94	8bit SQ, 8bit HQ, 10bit HQ
1080i*	1440	16:9	25, 29.97	8bit SQ
1080i*	1920	16:9	25, 29.97	8bit SQ, 8bit HQ, 10bit HQ
1080p	1920	16:9	23.976, 24, 25	8bit LQ
1080p	1920	16:9	23.976, 24, 25, 29.97	8bit SQ, 8bit HQ, 10bit HQ

*1080i Field Order: Upper Field First

DV and DVCPro Profiles

Table C–2. DV and DVCPro Profiles

Vertical	Horizontal	Aspect Ratios	Frame Rates	Quality (Mbps)
480i*, 486i*	720	4:3, 16:9	29.97	25, 50***
576i**	720	4:3, 16:9	25	25, 50***

*NTSC Field Order: Lower Field First

**PAL Field Order: Upper Field First

*** Available with Pipeline HD Dual Channel Only

DVCPro HD Profiles

Table C–3. DVCPro HD Profiles

Vertical	Horizontal	Aspect Ratios	Frame Rates	Quality (Mbps)
720p	960	16:9	23.976, 25, 29.97, 50, 59.94	100
1080p	1280	16:9	23.976	100
1080i*, 1080p	1280	16:9	29.97	100
1080i*, 1080p	1440	16:9	25	100

*1080i Field Order: Upper Field First

IMX Profiles

Table C–4. Avid IMX Profiles

Vertical	Horizontal	Aspect Ratios	Frame Rates	Quality (Mbps)
486i*	720	4:3, 16:9	29.97	30, 40, 50, Avid IMX***
576i**	720	4:3, 16:9	25	30, 40, 50, Avid IMX***

*NTSC Field Order: Lower Field First

**PAL Field Order: Upper Field First

*** 50Mb/s compatible with Avid QuickTime AMA

ProRes Profiles

SD Pipeline devices support ProRes SQ, LT and Proxy quality levels; HD Pipeline devices support ProRes HQ, SQ, LT and Proxy quality levels.

Table C–5. ProRes Profiles

Vertical	Horizontal	Aspect Ratios	Frame Rates	Quality (Mbps)
486i*	720	4:3, 16:9	29.97	SQ, HQ
576i**	720	4:3, 16:9	25	SQ, HQ
720p	960, 1280	16:9	23.976, 25, 29.97, 50, 59.94	SQ, HQ, LT, Proxy
1080p	1440, 1920	16:9	23.976	SQ, HQ, LT, Proxy
1080i***, 1080p	1440, 1920	16:9	25, 29.97	SQ, HQ, LT, Proxy

*NTSC Field Order: Lower Field First

**PAL Field Order: Upper Field First

***1080i Field Order: Upper Field First

Motion JPEG Profiles

Motion JPEG A is supported in SD profiles; Standard and HQ are supported in HD profiles.

Table C–6. Motion JPEG Profiles

Vertical	Horizontal	Aspect Ratios	Frame Rates	Quality (Mbps)
240p	320	4:3	25, 29.97	Q80
240p	427	16:9	25, 29.97	Q80

SD Uncompressed 8-bit Profiles

Table C–7. SD Uncompressed Profiles

Vertical	Horizontal	Aspect Ratios	Frame Rates	Quality (Mbps)
480i*, 486i*	720	4:3, 16:9	29.97	uncompressed
576i**	720	4:3, 16:9	25	uncompressed

*NTSC Field Order: Lower Field First

**PAL Field Order: Upper Field First

Linear PCM Profiles

Table C–8. Linear PCM Profiles

Parameter	Value
Channels	2 4 8 16
Sample Rate	48 KHz
Quality	16 24 bit, Big Endian Little Endian

Index

Symbols

.Net Framework 3.5, required 3-24

Numerics

525/625, automatic detection of 2-8, 2-10

554 port (RTSP) must be open 2-20

80, http port, must be open 2-20

A

About panel, generally 5-43

assemble edits, in Pipeline Control 10-138

audio flag, in print to tape 10-140

auto timecode clock source 6-67

Avid IMX C-161

Avid, MXF file support 4-26

B

back plane, HD Dual, ports and connectors 2-17

back plane, SC, ports and connectors 2-9

Big Endian C-162

BNC, SMPTE-259M 270MBPS 2-10, 2-14

Bonjour panel 4-30–4-31

C

Canadian EMC Notice of Compliance i-iii

Cat-5 cable, must be used with Pipeline i-ii

Channel 1 (Quad), timecode clock source 6-67

clip list files, loading and saving 6-81

clip list panel, using generally 8-120

clip list, creating for log and capture 8-117

clip panel, in print to tape documents 10-140,
11-149

clip, creating 8-124

clip, deleting 8-124

closed caption 1-2, 2-8

closed caption data extraction 2-8

closed caption, processing 2-15

comparison of features 4-26

computer clock, timecode source 6-67

confidence monitoring 1-2, 2-11, 5-50–5-52, 8-117,
9-127

confidence monitoring, disabling 5-51

confidence monitoring, enabling 5-51

Configure panel, generally 5-44

Connect dialog, authenticating with 5-42

Copy File, configuring publisher for 6-74

copyright notice i-i

Counters panel 5-53

CPLD chip version 5-45

crash records, in Pipeline Control 10-138

D

DAM 1-2

DHCP address 2-21, 5-49, A-153

dimensions, of Pipeline Quad 2-10, 2-14

dimensions, of Pipeline SC 2-8

DNxHD, Avid DNxHD 1-3

DV 2-10, 5-52

DVCPPro 2-10, 5-52

DVCPProHD 1-3

E

edit decision list 5-55

EDL 5-55

EDL files B-155

EDL for Pipeline syntax B-155

EDL, loading and saving 6-81

electrical safety, standards complied with i-iii

emission information i-ii

- emission standards complied with i-iii
- EN55022 Class A Warning i-iii
- environmental operating requirements 2-6
- Episode 2-8, 5-51
- Episode | Episode Pro, Pipeline Plugin for 4-26
- Episode, version requirements for use with Pipeline 4-27
- Ethernet 2-6, 2-8–2-9, 2-11
- Ethernet port (SC) 2-9
- Ethernet port, LED indicators for 2-14, 2-18
- Ethernet, gigabit 1-2, 2-10, 2-14
- Ethernet, gigabit in Quad 1-2
- Ethernet, gigabit port (HD Dual) 2-18
- Ethernet, gigabit port (Quad) 2-14

F

- FCC Emission Information i-ii
- features, comparison of Pipeline applications 4-26
- Final Cut Pro 1-2, 2-19, 2-21, 5-51, A-151, A-153
- Final Cut Pro version 5.0.1, requirement for using with Pipeline 4-27
- Final Cut Pro, Pipeline Plugin for 4-26
- firmware update 2-8, 2-11, 5-56
- FlipFactory 1-2, 2-8, 2-19, 2-21, 5-51, A-151
- FlipFactory / Pipeline workflow, system requirements for 4-37
- FlipFactory console 5-52
- FlipFactory, configuring publisher for 6-75
- FlipFactory, requirements for using with Pipeline 4-27
- FlipFactory, version requirements 4-27
- FPGA chip version 5-45
- front panel indicators 2-11, 2-16
- front panel indicators for SC 2-8

G

- gigabit Ethernet 1-2, 2-10, 2-14, 2-19
- gigabit Ethernet port (HD Dual) 2-18
- gigabit Ethernet port (Quad) 2-14

H

- hardware for Quad 2-10, 2-14
- hardware for SC 2-8
- HD Dual, reset switches 2-12, 2-16
- HTTP password rules 5-46
- http port 80, must be open 2-20

I

- IMX 2-10, 5-52
- insert edit 10-140
- insert edits, in Pipeline Control 10-138
- installing Pipeline software on 3-23
- installing Pipeline software on Windows 3-23
- installing Pipeline software, generally 4-25
- Internet Explorer 5-45
- Internet Explorer 6 5-41
- Internet Explorer, req'd settings for Pipeline Administrator 5-42

L

- LAN LED (HD Dual) 2-16
- LED SDI, front, on Quad, lights orange 2-11
- LED, Ethernet on Quad 2-14, 2-18
- LED, Ethernet on SC, lights orange 2-9
- LED, Ethernet, on SC, unlit 2-10
- LED, front, on Quad, lights yellow 2-11
- LED, on HD Dual front panel 2-16
- LED, on Quad front panel 2-11
- LED, on SC, lights orange 2-8
- LED, on SC, lights yellow 2-8
- LED, SDI on front, Quad, blinks orange 2-11
- LEDs 2-11, 2-16
- LEDs, for SC 2-8
- license requirements, for MPEG-2 i-i
- Link LED (Quad) 2-11
- link-local 2-20–2-21, 5-45
- link-local IP address, default 2-20
- Little Endian C-162
- log and capture window, using generally 8-118
- log and capture, generally 8-117
- loopback, disabling 5-47

M

- MAC address 2-21
- Mac OS X 2-19
- Mac OS X, Pipeline Control, supported 4-26
- Mode LED (HD Dual) 2-16
- MPEG-2, license requirements i-i
- MXF file support 4-26

N

- name of Pipeline, editing 5-45
- network settings, configuring 2-22
- notices

- Canadian EMC Notice of Compliance i-iii
- FCC emission information i-ii
- notices, legal, generally i-i
- NTSC 2-10

O

- operating temperatures 2-6
- overheating warning 2-6
- overheating, or Pipeline, avoiding 2-6

P

- PAL 2-10
- password, none by default, assigning 5-46
- Pipeline
 - adding to LAN 2-20
 - configuring and connecting 2-21
 - connecting directly to computer 2-19
 - dimensions of Quad 2-10, 2-14
 - dimensions of SC 2-8
 - LEDs 2-8
 - name, editing 5-45
 - network settings 2-22
 - power requirements 2-6
 - rebooting 5-49
 - registering 2-22
 - soft rebooting 5-49
 - version 5-45
- Pipeline Administrator
 - About panel 5-43
 - Configure panel 5-44
 - Upgrade panel 5-55
- Pipeline Administrator, generally 5-41
- Pipeline Administrator, launching 5-42
- Pipeline applications, features compared 4-26
- Pipeline clock, timecode source 6-67
- Pipeline Control, feature comparison 4-26
- Pipeline Control, supported 4-26
- Pipeline HD Dual
 - contents of shipping container 2-7
 - features 1-3
 - front panel indicators 2-16
 - locating for operation 2-7
 - rear panel 2-17
- Pipeline Plugin, feature comparison 4-26
- Pipeline Quad
 - contents of shipping container 2-7
 - features 1-2

- front panel indicators 2-11
- hardware, specifications 2-10, 2-14
- locating for operation 2-7
- rear panel 2-13
- Pipeline SC
 - contents of shipping container 2-7
 - features 1-2
 - front panel indicators 2-8
 - hardware, specifications 2-8
 - locating for operation 2-7
 - rear panel 2-9
- Pipeline software, general hardware and OS
 - requirements for 4-37
- Pipeline software, installing 4-25
- Pipeline software, installing on Windows 3-23
- Pipeline software, uninstalling from Windows 3-24
- Pipeline software, upgrading on Windows 3-24
- PipelineAdministrator 5-53
 - Quad panel 5-50
- ports, that must be open 2-20
- Postroll Duration 6-84
- power connector (HD Dual) 2-17
- power connector (Quad) 2-13
- power connector (SC) 2-9
- Power LED (SC) 2-8
- power requirements for Pipeline 2-6
- pre-roll 7-112
- preroll duration 6-84
- pre-roll value to VTR B-156
- pre-roll, excessive, problem 7-112, 8-121, 9-129
- Preview Panel, using generally 6-79
- preview panel, using in log and capture 8-119, 9-130
- Print Time Tape, in print to tape documents 10-142
- Print to Tape configuration panel 10-139, 11-147
- print to tape documents, creating,
 - generally 10-139, 11-147
- Print to Tape Timecode panel 10-140, 11-147
- print-to-tape operations, generally 10-137
- print-to-tape, requires QuickTime clips 10-139, 11-147
- ProRes 422 HD, Apple ProRes 422 HD 1-3
- publisher, configuring Copy File as 6-74
- publisher, configuring for FlipFactory 6-75
- publisher, configuring, generally 6-68
- publisher, selecting 6-68
- PWR LEDs (HD Dual) 2-16
- PWR LEDs, on Quad 2-12

Q

Quad panel, generally 5-50
 QuickTime file support 4-26
 QuickTime format, used exclusively in print-to-tape ops 10-139, 11-147

R

Radiation Emission Susceptibility Regulatory Approved Standards
 complied with i-iii
 rear panel, HD Dual, ports and connectors 2-17
 rear panel, Quad, ports and connectors, back plane, Quad, ports and connectors 2-13
 rear panel, SC, ports and connectors 2-9
 rebooting, Pipeline 5-49
 Reference LED (HD Dual) 2-16
 Register, using button on About panel 5-43
 registering your Pipeline 2-22
 registering, URL for 5-43
 reset switches, HD Dual 2-12, 2-16
 RS-422 2-9–2-10, 2-13–2-14, 2-17–2-18, 2-21, 5-54, 6-79, 8-119–8-120, 9-128, 9-130, 10-138
 RS-422 deck control 2-8
 RS-422 port (Quad) 2-13
 RS-422 port (SC) 2-9, 2-13
 RS422, timecode clock source 6-67
 RTSP port 554 must be open 2-20

S

Safari 5-45
 safety instructions when using Pipeline i-iii
 SDI In (HD Dual), indicators for 2-16
 SDI In (SC) 2-8
 SDI In LED (Quad) 2-11
 SDI In port (HD Dual) 2-18
 SDI In port (Quad) 2-14
 SDI In port (SC) 2-9
 SDI LED (SC) 2-8
 SDI Out (HD Dual), indicators for 2-16
 SDI Out (SC) 2-9
 SDI Out LED (Quad) 2-11
 SDI Out port (Quad) 2-14
 SDI Out port (SC) 2-10
 SDI Out, indicators for 2-18
 SDI Sync Input (HD Dual) 2-17
 SDI time code 6-67
 Serial Digital Interface 2-8, 2-10, 2-14

settings, returning to default 5-49
 SMPTE-259M 270MBps 2-8
 soft rebooting, Pipeline 5-49
 Sony Protocol 2-8
 stack limit two, overheating 2-6
 Static IP address 5-45
 static IP address 2-20–2-21, 5-49, A-153
 surge protector, recommended 2-6
 Sync In (HD Dual) 2-17
 Sync In port (Quad) 2-13
 Sync LED (HD Dual) 2-16
 Sync LED (Quad) 2-12
 Sync Out (HD Dual) 2-18
 Sync Out port (Quad) 2-13
 sync reference 1-2, 2-12, 2-16
 sync reference, using in HD 2-15
 sync reference, using in Quad 2-10

T

TCP ports that must be open 2-20
 Telestream
 contacting i-iv
 International i-ii
 sales and marketing i-i–i-ii
 technical support i-i–i-ii
 Web site i-i–i-ii
 Telestream, contacting i-ii
 temperature, operating requirements for 2-6
 TIFO file support 4-26
 time code 1-2, 2-15, B-155
 time code, processing 2-8, 2-15
 timecode clock source, Auto 6-67
 timecode clock source, Channel 1 (Quad) 6-67
 timecode clock source, RS422 6-67
 timecode clock source, video input 6-67
 timecode clock source, Zero based 6-67
 timecode clock sources, options 6-67
 timecode source, computer clock 6-67
 timecode source, Pipeline clock 6-67
 trademark notice i-i
 trigger document, in Pipeline Control, generally 9-127
 trigger window, using generally 9-128

U

UDP ports that must be open 2-20
 Uncompressed SD 8- and 10-bit 1-3

uninstalling Pipeline software from Windows 3-24
Upgrade panel 5-55
upgrading software on Windows 3-24

V

VANC Closed Caption and Time Code, processing
with Pipeline 2-15
VBI Closed Caption and Time Code, processing
with Pipeline 2-8
version 5-45
Vertical Blanking Interval, processing 2-8
Video Input, timecode clock source 6-67
VITC time code 1-2
VTR 6-62, 6-67, 6-79, 7-108, 8-117, 8-119–8-121,
8-124, 9-127–9-128, 9-130, 9-134,
10-137–10-138, B-156
VTR RS-422 2-20

W

warranty i-iv
Warranty and Disclaimers i-iv
Web browsers
supported 5-41
Windows 2-19
Windows, installing Pipeline software on 3-23
Windows, uninstalling Pipeline software from 3-24
Windows, upgrading Pipeline software on 3-24
workflows for FlipFactory, version
requirements 4-27

Z

Zero based, timecode clock source 6-67