

SPG9000

The Go-To Solution for
Synchronization, Timing,
and Reference Test
Signal Generation



Introducing the SPG9000

- Two independent 1G/10G ports for PTP, supporting dual leader, dual follower, and follower + leader configurations
- Integrated multi-system (GPS, GLONASS, BeiDou, Galileo, QZSS) dual-band GNSS receiver for a highly accurate and reliable timing source
- Analog genlock input and multiple sync outputs for legacy and hybrid SDI/IP facilities
- Multiple video/audio/data test signal generators for formats from SD to HD/2K to UHD/4K
- 4 multi-rate (SD-SDI to 12G-SDI) SDI test signal outputs
- 2 10G/25G Ethernet ports for ST 2110 test signal streams with ST 2022-7 redundancy
- NMOS management of IP sender configuration
- Secure web interface for remote operation and REST- style HTTP API for easy integration with third-party management software

The versatile SPG9000 sync generator caters to the diverse needs of SDI, IP, or hybrid SDI/IP video facilities. It provides unparalleled flexibility by seamlessly integrating into your workflow. Whether you are using SDI exclusively or making the transition to IP, the SPG9000 easily adapts to your requirements.

Advantages of SPG9000

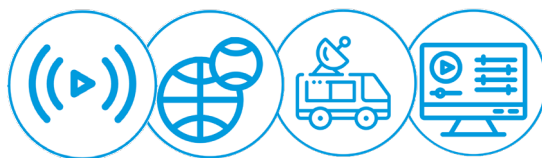

- Ideal for use in broadcast, sports, mobile live production, and post-production
- Seamlessly adapts to multiple timing sources: GNSS, PTP, black burst, 10MHz, and NTP
- Highly versatile with reference distribution options such as PTP, NTP, black burst, and DARS
- Sets up fast as a Grandmaster or Follower using PTP
- Ensures precise timing and seamless connectivity by producing known-good references for SDI and IP
- Offers a user-friendly web interface
- Supports a multitude of post-production signal formats including SD, HD, 3G, 4K, and UHD

Unmatched IP Synchronization and Redundancy



IP-Based Video Facilities

In modern IP-based facilities, PTP is distributed for timing and synchronization to a common source. The SPG9000 can use a GNSS signal as the time source and serve as a PTP grandmaster for the video network. With two independent ports and PTP engines, each SPG9000 can provide PTP for two different domains (e.g. ST 2059 and AES67) or can connect to both sides of redundant networks.

For easy connectivity to spine or backbone switches, each PTP port of the SPG9000 can connect at either 10 Gbps or 1 Gbps line rate, using SFP+ transceiver modules.

Each PTP instance of the SPG9000 can operate as a leader only, a follower only, or use “Ordinary Clock” mode which can adapt between leader and follower as required. For example, if GNSS- based time synchronization is not available (perhaps because there is no clear view of the sky for the antenna), a pair of SPG9000 systems can still function as a primary + backup pair for redundancy. The backup will use PTP to sync to the primary, and takeover with no time disturbance when it switches from follower to leader.

The SPG9000 can also function as an NMOS-controlled media sender, generating video, audio and data reference test signals over ST 2110 IP streams. The two 25 Gbps ports for IP traffic can operate independently or as redundant links per ST 2022-7.

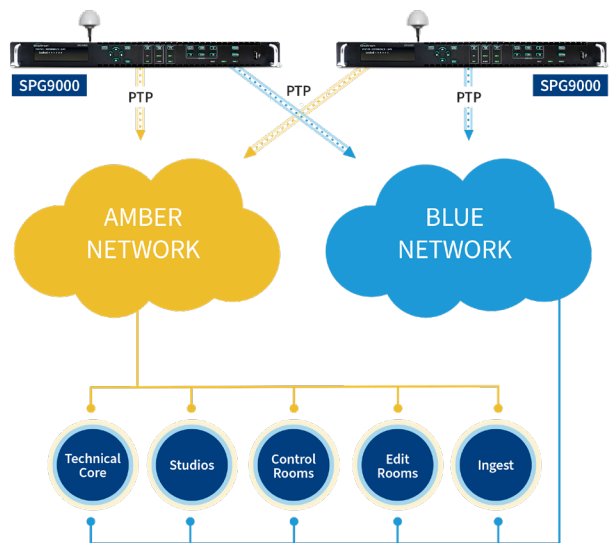

Optimal Synchronization Made Easy for SDI and Hybrid Workflows

SDI/Analog Video Facilities

The SPG9000 is a full-featured sync pulse generator, providing all the necessary reference signals for an SDI-based video facility. The SPG9000 can lock to a GNSS signal or genlock to another SPG. It has six analog outputs for NTSC/PAL black burst, HD tri-level sync, 10 MHz continuous wave, or 1 pulse-per-second signals, each with independent timing offsets. Time code can be distributed from four LTC outputs and from VITC on any NTSC/PAL black outputs. Word Clock and Digital Audio Reference Signal (DARS) outputs are available for audio reference.

The SPG9000 also includes four multi-rate SDI test signal outputs that can operate independently for SD, HD-SDI (1.5G and 3G), and UHD (12G-SDI) formats.

Along with the companion ECO8000 changeover unit, a pair of SPG9000 units (primary and backup) comprise a highly available synchronization solution.

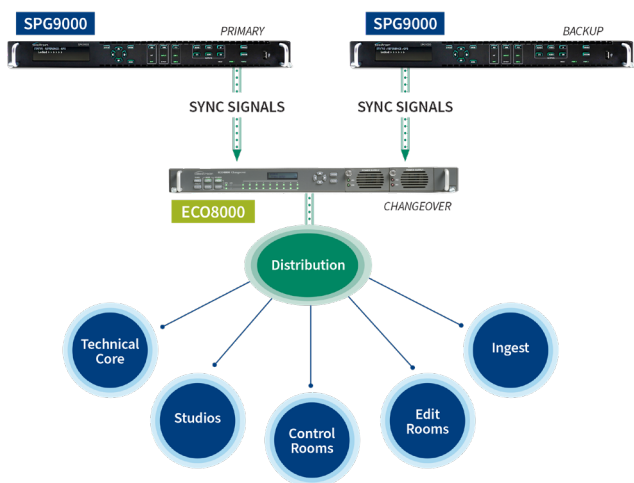

Hybrid SDI/IP Video Facilities

The SPG9000 is ideal for facilities that have a hybrid mix of IP-based equipment and SDI/analog equipment. SPG9000s can serve as PTP grandmasters for the facility's time and synchronization source. PTP is distributed through the facility, and directly to IP-based devices. At the network edge, additional SPG9000 units (either standalone or paired in a primary/backup configuration with an ECO8000) can operate as PTP followers and lock to the active grandmaster. This reference is then used to generate analog sync and time code signals for SDI/analog equipment that uses a traditional genlock input. This system architecture ensures that all equipment in the facility is synchronized to the same time source.

Test signal outputs of each SPG9000 can be configured to duplicate the same video test patterns to both IP and SDI outputs, or they can be configured to use separate test patterns.

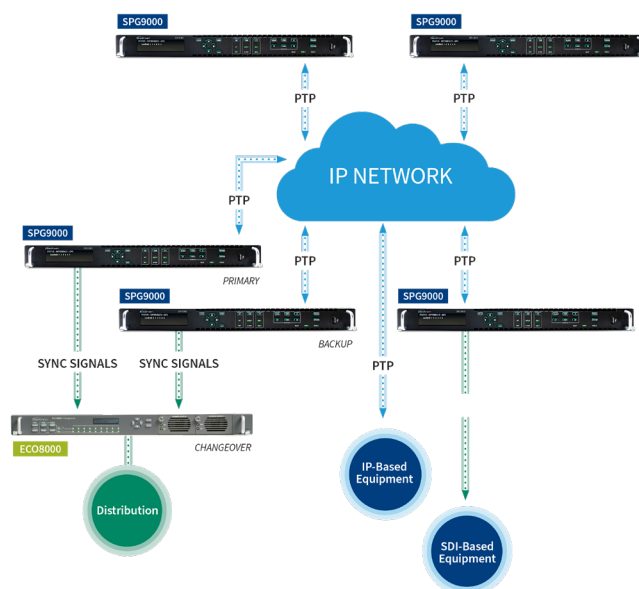



Flexible Configuration Options for Any System Architecture

The SPG9000 offers a complete set of reference inputs and outputs, supporting a wide variety of system designs. The base configuration includes all the features of a complete sync pulse generator, and all options are licensed so that they can be purchased with the base unit or any time later to upgrade the system.

The SPG9000 has multiple options for setting the internal clock reference (frequency and time-of-day). It can lock to a received GNSS signal, to another PTP grandmaster, or to another sync generator or an external atomic clock using the analog genlock input.

The loop-through genlock input can lock to many different types of analog synchronization signals, including NTSC and PAL black burst, HD tri-level sync signals for all common 1080-line and 720-line frame rates and formats, and continuous wave (CW) signals at 10 MHz.

Resilient to Interruption and Reliable for Continuous Operation

Resiliency and reliability are essential attributes for a timing reference generator since it is a mission-critical component for the video facility.

The SPG9000 has a high-quality oven-controlled micro-electromechanical system (MEMS) oscillator for its internal clock. If the received GNSS signal or genlock input signal is temporarily lost, the SPG9000 will switch to holdover mode in which this clock maintains its time and phase from the previous lock. When the reference input signal is restored, the holdover recovery process adjusts the clock slowly to eliminate any accumulated phase difference. Avoiding an abrupt “jam” when the SPG9000 is re-locked ensures that no “synchronization shock” will be observed by follower devices.

Most facilities require the timing reference to be available continuously and the SPG9000 has an innovative dual power supply system to assist high availability. Unlike simpler devices, the SPG9000 has a designated active power supply and an idle backup supply. This ensures that they are not used at the same rate and will not potentially fail at about the same time. The SPG9000 will monitor the temperature-weighted hours of the active supply and alert the user when it approaches the rated limit. The backup supply undergoes a brief load test automatically each day and the user can be notified if this test fails.

Integrated Dual-Band GNSS Receiver

In addition to their main purpose of providing position information, Global Navigation Satellite Systems also provide highly accurate time-of-day information. Video systems can use this time to compute the precise number of video and audio frames since the “epoch” date and time, thereby synchronizing signals even from disconnected systems.

The SPG9000 has an integrated multi-GNSS, dual-band receiver, supporting GPS, GLONASS, Galileo, BeiDou, and QZSS satellite constellations at L1 and L5 frequencies as applicable. Unlike “smart” antennas that include an internal receiver, the SPG9000’s antenna produces a simple RF signal that can be brought to the SPG9000 by plain coaxial cable, greatly simplifying installation and maintenance.

The SPG9000 constantly monitors the received GNSS signal, showing the ID, status, and signal strength of each satellite currently in view. This information can be viewed on the web interface and retrieved via the HTTP API, providing valuable diagnostic information when investigating signal reception issues.

Complete PTP Solution for Today’s IP Video Networks

The SPG9000 includes an advanced implementation of the Precision Time Protocol, making it the ideal choice for a facility’s timing and synchronization reference.

Both Leader and Follower modes are supported, and the SPG9000 can also operate as an “Ordinary Clock” that adapts between the two modes depending on dynamic network conditions. With two independent PTP instances, the SPG9000 can operate as a dual Leader serving two different domains and/or profiles, as a dual Follower connected to the two sides of a redundant network, or simultaneously as a Follower synchronized to an upstream grandmaster and as a Leader to a separate downstream network. The PTP ports operate over 1G/10G-capable interfaces (using SFP+ modules) for easy connection to commonly used switch ports.

The SPG9000 supports the three profile types required for media networks: SMPTE ST 2059-2, AES67 Media Profile, and IEEE 1588 Default. Both multicast and unicast communication models are supported, including mixed multicast/unicast mode.

Key Features

PTP performance monitoring per IEEE 1588-2019 Annex J is supported, with real-time display of delay and offset measurements and message rates. The data is also available via the HTTP API, for easy integration with management dashboards.

The SPG9000 has a unique Dynamic Priority algorithm that minimizes unnecessary grandmaster changes. For example, it is normal and expected behavior for the Best Master Clock Algorithm (BMCA) to cause a switch from a primary (active) leader to a backup (passive) leader when the GNSS signal degrades. But if that signal is restored, the current active leader is equally capable of serving PTP to the network, so there is no need to switch back to the original leader. Dynamic Priority ensures that the unnecessary GM change does not happen, improving stability for ST 2110 and PTP networks.

Powerful Test Signal Generator

Test signals are useful video and audio references that can be used to troubleshoot or verify performance of equipment and network links within the facility. The SPG9000 includes video, audio, and ancillary data generators for four multi-rate (up to 12G) SDI outputs and two 25 Gbps IP outputs.

A wide variety of standard video test patterns are available, such as color bars, monitor calibration patterns, ramps and staircases, and multiburst patterns. Formats and image sizes from standard definition to UHD/4K are supported simultaneously on the independent outputs.

The SPG9000 has multiple independent audio tone generators that can be embedded into the SDI signals and output as ST 2110-30 IP streams.

Ancillary data can be included in the SDI signals and output as ST 2110-40 IP streams. Ancillary time code and video payload identifier (SDI only) are supported.



NMOS-Enabled Media Sender

Using the Networked Media Open Specifications (NMOS) developed by the Advanced Media Workflow Association (AMWA), the SPG9000 can function as a media device in an IP network.

Using the Discovery & Registration API (IS-04), the SPG9000 can register as a node with sender capabilities. Using the Device Connection Management API (IS-05), receivers can automatically configure IP connections to receive IP streams for test signal content (video, audio, and data).

Remote System Management and Monitoring

The SPG9000 includes several tools to facilitate easy integration with modern management systems and monitoring dashboards.

In addition to the front panel display and keypad for local operation, the SPG9000 has a full-featured easy-to-use web-based interface for remote operation. Access is controlled via user login and password authentication, with both administrator and operator access levels. HTTPS can be used for secure network access per EBU R 143 cybersecurity requirements.

A complete HTTP-based Application Programming Interface (API) is available for client-side software to query the instrument status and to configure its run-time options. Integrated web-based API documentation makes it easy for developers to understand message structures, and to interactively send requests to the instrument and view the responses.

The SPG9000 also utilizes syslog for sending log messages to a remote server. The minimum reported severity level is configurable, to only report error and warning messages or to also report informational system messages, for example.

PTP status and performance monitoring and GNSS receiver status are well-supported by both the HTTP API and syslog. The API conforms with the proposed SMPTE RP 2059-15 data model, providing a vendor-neutral interface for client-side developers.

The SPG9000 has an SNMP agent for system monitoring with traditional management systems. SNMP version 3 is used for security, and the agent supports objects for system and reference status and Trap messages for event notifications.

Companion Changeover Unit

The ECO8000 electronic changeover unit works with a primary + backup pair of SPG9000 units to serve as a highly-reliable redundant system. It utilizes electronic fast switches for near glitch-less sync source switching, minimizing disruption in operation. Dual hot-swappable power supplies ensure continuous availability of reference signals, and signals are passed even when the unit is powered off.

The ECO8000 provides nine user-configurable BNC channels and four LTC channels. Each channel consists of primary and backup inputs, and an output. The system includes six 50 MHz electronic fast switch channels, three 3 GHz relay switch channels, and four LTC channels. The 50 MHz electronic fast switch channels support black burst, HD tri-level sync, AES/DARS, and word clock signals. The 3 GHz relay switch channels support SD/HD/3G-SDI signals as well as most analog reference signals.



SPG9000

Tech Specs



Form Factor and Dimensions

Front View

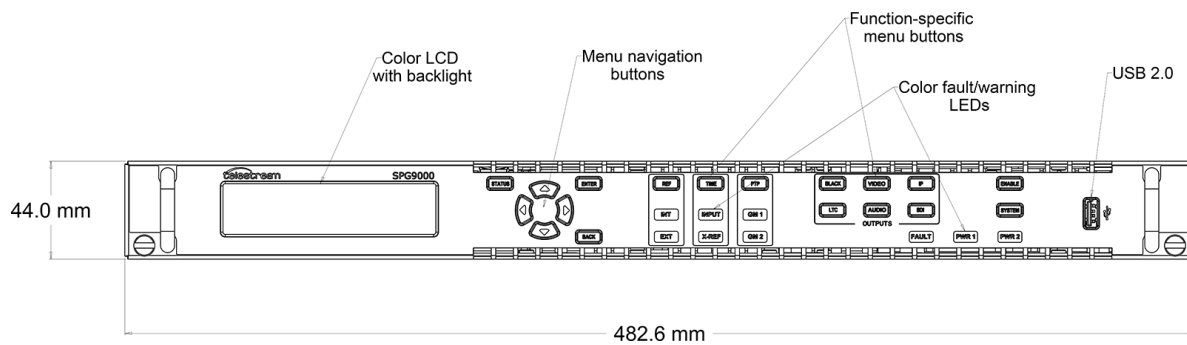

Side View

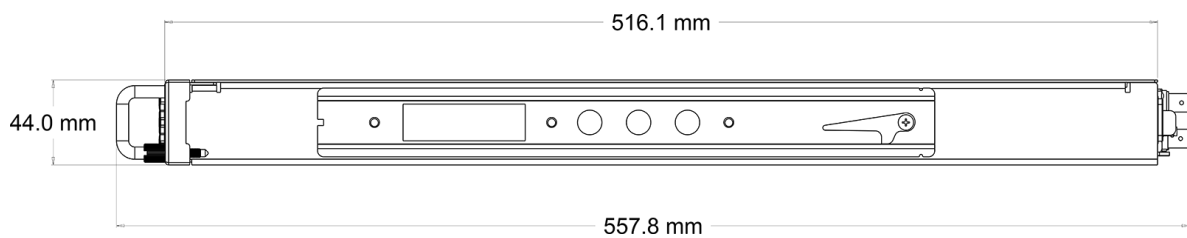

Dimensions

Height	44.0 mm (1.73 in.)
Width	482.6 mm (19 in.)
Depth	516.1 mm (20.32 in.)
Weight	4.85 kg (10.7 lbs)

Connectivity

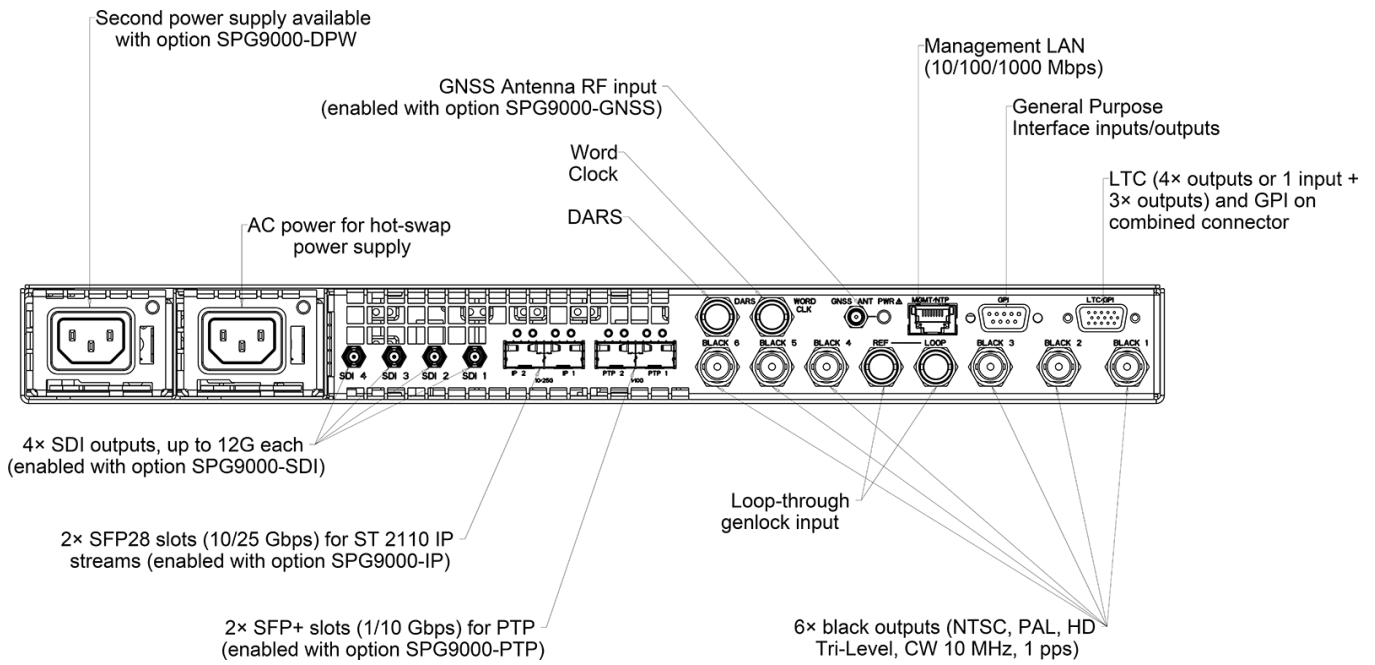

Baseband Synchronization

Internal Oscillator

Frequency accuracy in internal/holdover modes	$\pm 155 \times 10^{-9}$ over 1-year calibration interval; typically $\pm 10 \times 10^{-9}$ just after adjustment
Frequency drift	$< \pm 100 \times 10^{-9}$ per year for internal and holdover modes at constant temperature

Genlock Input

Connector	BNC ×2, passive loop-through
Formats	<ul style="list-style-type: none">• NTSC/PAL black burst• HD tri-level sync<ul style="list-style-type: none">◦ 1080 60/59.94/50i◦ 1080 30/29.97/25/24/23.98p◦ 1080 24/23.98sF◦ 720 60/59.94/50p• CW 10 MHz
Amplitude Range	-8 dB to +6 dB
Lock Stability	
±3 dB amplitude change	<1 ns
Jitter with burst lock	<0.5°
Jitter with tri-level sync lock	<1 ns
Jitter with CW lock	<1 ns (typ. 1°)
Timing Adjustment	
Range	$\pm \frac{1}{2}$ color frame
Resolution	<0.5° of NTSC/PAL subcarrier, 1 ns for tri-level sync

Baseband Synchronization

Black Outputs

Number of Outputs	6
Formats	<ul style="list-style-type: none">• Black burst<ul style="list-style-type: none">◦ NTSC-M (7.5 IRE black)◦ NTSC-J (0 IRE black)◦ PAL-B• HD tri-level sync<ul style="list-style-type: none">◦ 1080 60/59.94/50i◦ 1080 60/59.94/50/48/47.95/30/29.97/25/24/23.98p◦ 1080 24/23.98sF◦ 720 60/59.94/50p• CW 10 MHz• 1 pps
Amplitude Accuracy	± 2%
Timing Adjustment Range Resolution	± ½ color frame Clock resolution: 18.5 ns for black burst, 13.5 ns for HD tri-level Fine resolution: 0.1 ns for black burst, 0.2 ns for HD tri-level
Time Code (VITC) Line Numbers Date and Time Zone Source	User-selectable 1 or 2 lines, default 14/16 for NTSC, 19/21 for PAL SMPTE ST 309, YYMMDD format Time-of-day with adjustable offset, or program (elapsed) time counter
Ten-Field Sequence	For NTSC formats per SMPTE ST 318 (Black 4-6 outputs only)

LTC Input/Outputs

Number of Outputs	4 outputs or 3 outputs and 1 input
Connector	Available through D-sub 15-pin connector; Optional break-out cable to XLR connectors
Formats	24 fps (24 Hz or 23.98 Hz), 25 fps, 30 fps, 30 fps drop-frame (29.97 Hz) per SMPTE ST 12-1
Source	Time-of-day with adjustable offset, or program (elapsed) time counter
Output Amplitude	5V ±10%, adjustable from 0.5 V to 5 V in 0.5 V steps

Baseband Synchronization

Word Clock

Connector	BNC ×1
Frequency	48 kHz
Output Level	0-5 V DC (CMOS compatible) or ±1 V into 75 Ω (AES level)

DARS

Outputs	Outputs 2 channels (1 AES/EBU pair)
Connector	BNC ×1
Amplitude	1 V ± 0.2 V
Sampling Frequency	48 kHz (lock on video signal)
Quantization	Linear PCM, 20 or 24 bits

Network Time Protocol (NTP)

Network Interface	Combined MGMT/NTP interface for management functions and NTP server/client RJ45 connector, 10/100/1000 Mbps line speed
Server	
Stratum Level	Stratum 1 when the reference time source is GNSS or PTP Follower Optional Stratum 12 operation for internal time or LTC/VITC time source
Client Query Rate	Maximum 1 query per 8 seconds for each individual client Rate limiting is enabled to prevent DoS attacks
Number of Clients	5000 or more at maximum query rate
Client	
Operation	Available when using internal time source Update internal time from NTP manually, upon system startup, from API, or from GPI
Remote Time Servers	One or two remote servers from local network or Internet

Precision Time Protocol (PTP)

Port Connectors	2× SFP+ sockets. Available transceiver modules for 1G or 10G line speeds.
Operating Modes	Leader only, Follower only, Ordinary Clock (adaptive).
PTP Instances	2 independent, as dual Leader, dual Follower or Follower + Leader
Profiles	SMPTE ST 2059-2, AES67 Media Profile, IEEE 1588-2019 Default
Communication Model	Multicast, Unicast, Mixed Multicast/Unicast
Follower Lock Time	Typically 30 seconds for initial lock
Follower Lock Range	± 7.5 ppm
Measurements	For follower, shown on user interface or available via API <ul style="list-style-type: none">• Offset from Master• Path Delay• Leader-Follower Delay• Follower-Leader Delay
Status Reporting	Current GM Clock Identity, Clock Class, Clock Accuracy, Time Source Message rates for Announce, Sync, Delay_Req, and Delay_Resp messages
SMPTE Synchronization Metadata	For ST 2059-2 profile, automatically inserted in TLV data of Management messages for leader instances, and automatically decoded for follower instances

Global Navigation Satellite System (GNSS)

GNSS Receiver

Constellations	GPS, GLONASS, Galileo, BeiDou, QZSS
Frequency Bands	L1 1575.42 MHz and 1602 MHz (GPS, GLONASS, Galileo) L1 1561.098 MHz (BeiDou) L5 1176.45 MHz (GPS, QZSS, Galileo, BeiDou)
Time Accuracy	Within 150 ns to UTC
Acquisition Time	2 minutes on boot up with warm oven, good satellite signal, and known position
Status Reporting	Available via user interface and API <ul style="list-style-type: none">• Satellites in view and in fix• Per-satellite signal information• Position

GNSS Antenna Input

Connector	SMA female
Input Impedance	50 Ω , internally terminated
DC antenna power output voltage	3.3 V or 5 V at 55 mA
Fault Protection	Short-circuit/open detection and protection
Return loss	15 dB for L1 band at 1575 MHz 7 dB for L5 band at 1176 MHz
Signal Strength	Recommended 18 dB above ambient level after cable loss and signal amplifiers

Test Signal Generation

Video Formats

All listed formats are available for SDI outputs. ST 2110-20 video streams support 10-bit 4:2:2 progressive and interlaced formats for all listed image sizes and frame rates.

Image Size	Scan Type	Frame Rate	Sampling	Color Space	Bit Depth		
720x486	Interlaced	29.97	4:2:2	YCbCr	10		
720x576	Interlaced	25	4:2:2	YCbCr	10		
1280x720	Progressive	60/59.94/50 30/29.97/25/24/23.98	4:2:2	YCbCr	10		
			4:4:4	YCbCr	10		
			4:4:4	RGB	10		
1920x1080	Progressive	60/59.94/50 30/29.97/25/24/23.98	4:2:2	YCbCr	10		
			4:4:4	YCbCr	10		
			4:4:4	RGB	10		
			4:4:4	YCbCr	12		
			4:4:4	RGB	12		
			4:2:2	YCbCr	12		
	Interlaced	30/29.97/25	4:2:2	YCbCr	10		
			4:4:4	YCbCr	10		
			4:4:4	RGB	10		
			4:4:4	YCbCr	12		
			4:4:4	RGB	12		
			4:2:2	YCbCr	12		
	Segmented	30/29.97/25/24/23.98	4:2:2	YCbCr	10		
			4:4:4	YCbCr	10		
			4:4:4	RGB	10		
2048x1080	Progressive	60/59.94/50/48/47.95 30/29.97/25/24/23.98	4:2:2	YCbCr	10		
			4:4:4	YCbCr	10		
			4:4:4	RGB	10		
			4:4:4	YCbCr	12		
			4:4:4	RGB	12		
			4:2:2	YCbCr	12		
		30/29.97/25/24/23.98	4:4:4	XYZ	12		
			Segmented	30/29.97/25/24/23.98	4:2:2	YCbCr	10
					4:4:4	YCbCr	10
	4:4:4	RGB			10		
	4:4:4	YCbCr			12		
	4:4:4	RGB			12		
	4:2:2	YCbCr			12		
	4:4:4	XYZ	12				

Test Signal Generation

3840X2160	Progressive	60/59/94/50	4:2:2	YCbCr	10
		30/29.97/25/24/23.98	4:2:2	YCbCr	10
			4:4:4	YCbCr	10
			4:4:4	RGB	10
			4:4:4	YCbCr	12
			4:4:4	RGB	12
			4:2:2	YCbCr	12
4096X2160	Progressive	60/59/94/50/48/47.95	4:2:2	YCbCr	10
		30/29.97/25/24/23.98	4:2:2	YCbCr	10
			4:4:4	YCbCr	10
			4:4:4	RGB	10
			4:4:4	YCbCr	12
			4:4:4	RGB	12
			4:2:2	YCbCr	12

Video Encoding

Colorimetry	BT.601, BT.709, or BT.2020 per source format
Transfer Characteristics	SDR, HDR HLG, HDR PQ
Range	Narrow or Full, as permitted by source format

Video Test Patterns

Color Bars	100%, 75%, Bars Over Red, SMPTE EG1, SMPTE RP219-1 and RP219-2, BT.2111 (HLG Narrow, PQ Narrow, PQ Full), EBU 3373, NBCU HLG, Sony S-Log3, ARIB B28, ARIB B66
Monitor	BT.814 SD/SDR/HDR Pluge, Pluge and Luma Reference, Convergence, Production Aperture, Clean Aperture, Checkerboard, Window, EBU 3374 EOTF Validation, Black-White Step Scale, Black-Dark Gray Step Scale, SMPTE 303M Color Reference, SMPTE EG432-1 Color Accuracy, ChromaDuMonde
Linearity	Valid Ramps (Y, B-Y, R-Y), Limit Ramp, 3 Channel Ramp, Shallow Ramp Matrix, Color Ramp Matrix, 5/10 Step Staircases
Flat Field	0% Black, 50% Gray, 100% White, 100% Red/Green/Blue/Cyan/Magenta/Yellow, Interlaced Field Test
SDI Pathological	Equalizer Test, PLL Test, Checkfield per SMPTE RP198, Full-Length and Half-Length variants, Bandwidth Test, Matrix, Matrix with Color Bars
Frequency Response	Multiburst, various packet frequencies
Pulses	2T Pulse and Bar, Color Pulses, Co-siting Pulse

Test Signal Generation

Audio Tones

Number of Tones	32 independent tone generators. Each tone generator can be used for any individual SDI embedded audio channel and any individual ST 2110-30 audio channel.
Sampling	48 kHz
Resolution	24 bits (HD and UHD), 20 bits (SD)
Frequency	10.0 Hz to 20000.0 Hz, 0.5 Hz resolution
Amplitude	-60 to 0 dBFS, 1dB steps or mute
Channel Identification	Audible click, AES channel origin

Serial Digital Interface (SDI)

SDI Outputs

Number of Outputs	4
Connector	HD-BNC
Output Impedance	75 Ω
Output Amplitude	800 mV _{p-p} \pm 3%
Rise/Fall Time	
SD	\leq 700 ps (20-80%), 550 ps typ.
1.5G/3G	\leq 100 ps (20-80%), 60 ps typ.
6G/12G	\leq 42 ps (20-80%), 30 ps typ.
Jitter	
SD	210 ps typ. (alignment), 300 ps typ. (timing)
1.5G	40 ps typ. (alignment), 70 ps typ. (timing)
3G	30 ps typ. (alignment), 60 ps typ. (timing)
6G/12G	15 ps typ. (alignment), 45 ps typ. (timing)
Return Loss	\geq 25 dB typ. from 5 MHz to 2 GHz \geq 15 dB typ. from 2 GHz to 3 GHz \geq 10 dB typ. from 3 GHz to 6 GHz \geq 10 dB typ. from 6 GHz to 12 GHz

Serial Digital Interface (SDI)

SDI Formats

Standard Definition (SD-SDI)	
Interface Bit Rate	270 Mbps
Standards	SMPTE ST 259 Level C, ST 272,
Formats	720×486 (525-line) and 720×576 (625-line)
High Definition (HD-SDI)	
Interface Bit Rate	1.485 Gbps and 1.485/1.001 Gbps
Standards	SMPTE ST 274, ST 292-1, ST 296
Formats	1920×1080, 2048×1080, 1280×720 4:2:2 10-bit
3G-SDI	
Interface Bit Rate	2.97 Gbps and 2.97/1.001 Gbps
Standards	SMPTE ST 424, ST 425-1
Formats	1920×1080, 2048×1080, 1280×720 Level A, Mapping Structures 1, 2, 3, and 4 Level B, per ST 372 Mapping Structures I, II, III, and IV
6G-SDI	
Interface Bit Rate	5.94 Gbps and 5.94/1.001 Gbps
Standards	SMPTE ST 2081-10, ST 425-3
Formats	1920×1080, 2048×1080, 3840×2160, 4096×2160 ST 2081-10 Mode 1 and Mode 2
12G-SDI	
Interface Bit Rate	11.88 Gbps and 11.88/1.001 Gbps
Standards	SMPTE ST 2082-10, ST 425-5
Formats	3840×2160, 4096×2160 ST 2082-10 Mode 1

Embedded Audio

Number of Channels	16 (4 groups of 4 channels each)
Channel Control	Enable/Disable per group Active/Inactive per channel
Standard	SMPTE ST 299-1

Ancillary Data

Ancillary Time Code	ATC_LTC and/or ATC_VITC per SMPTE ST 12-2
Source	Local time-of-day with adjustable offset, UTC, or program (elapsed) time counter
Format	24 fps, 25 fps, 30 fps drop-frame, 30 fps non-drop per video format
Payload Identifier	Per SMPTE ST 352, automatic or manual override
Error Detection and Handling	EDH packet inserted in SD-SDI per SMPTE RP 165

Internet Protocol (IP)

IP Ports

Port Connectors	2 SFP28 sockets
Line Speed	10 Gbps or 25 Gbps per installed SFP type
Error Correction	RS-FEC per Clause 108 of IEEE 802.3by-2016 Enable/disable for 25G SFPs, not applicable for 10G SFPs

ST 2110 Generation

Operating Modes	Stream generation on both ports per SMPTE ST 2022-7 or on either individual port
Number of Streams	8× ST 2110-20 video streams 8× ST 2110-30 audio streams 4× ST 2110-40 data streams
Sender Type	Type N – Gapped PRS
RTP Payload Type	Independent value (96–127) per stream
UDP Size Limit (MAXUDP)	1460 octets
UDP Port Numbers	Independent source and destination port numbers for both paths of each stream
Destination Address	Multicast, 224.0.2.0 to 239.255.255.255 Independently configured for both paths of each stream
Session Description Protocol (SDP)	Available via web interface and API for each enabled stream
ST 2110-20 Video Packing Mode TR_{OFFSET}	General Packing Mode (GPM) or Block Packing Mode (BPM) Automatically calculated or Manual override
ST 2110-30 Audio Number of Channels Channel Order Packet Time	Each stream is independently configured for 1, 2, 4, 6, 8, or 16 channels Manual configuration, signaled via SDP 1 ms or 125 μ s
ST 2110-40 Data Payload Formats	Ancillary Time Code (ATC_LTC or ATC_VITC) per SMPTE ST 12-2 Time code format of 24 fps, 25 fps, 30 fps, or 30 fps drop-frame Associated video format of 525, 625, 750, 1125 or 2250 lines

Internet Protocol (IP)

Networked Media Open Specifications (NMOS)

Specifications	IS-04 NMOS Discovery and Registration IS-05 NMOS Device Connection Management
Registry Discovery	Automatic using DNS-SD (unicast or multicast) or Manual
API Versions	
Node	v1.0, v1.1, v1.2, v1.3
Connection	v1.0, v1.1
Registration	v1.0, v1.1, v1.2, v1.3
Data Model	The SPC9000 is represented as one Node, consisting of one Device, consisting of 20 Senders (8 video, 8 audio, 4 data)

Power Consumption

Typical	130 VA
Maximum	180 VA
Voltage Range	100 to 240 VAC ±10%, 50/60 Hz

Packaging Dimensions

Height	29.2 cm (11.5 in.)
Width	64.1 cm (25.2 in.)
Depth	73.7 cm (29.0 in.)
Weight	9.6 kg (21.2 lbs.) with no options 12.0 kg (28.7 lbs.) with all options

Ordering Information

Base Model

Product Code	Description
SPG9000	SPG9000 timing and reference generator; includes loop-through genlock input, 6 analog black/tri-level outputs, 4 LTC outputs, word clock output, DARS output, general-purpose interface, and management LAN interface

Licensed Feature Options

Option Code	Description
SPG9000-GNSS	License; SPG9000, Enable internal GNSS receiver and time synchronization features
SPG9000-PTP	License; SPG9000, Enable PTP (IEEE 1588) support on two ports
SPG9000-SDI	License; SPG9000, Enable SD/HD/UHD test signal generation on four SDI outputs
SPG9000-IP	License; SPG9000, Enable ST 2110 test signal generation on two IP ports
SPG9000-TSG	License; SPG9000, Includes both SDI and IP licenses for test signal generation

Accessory Options

Option Code	Description
SPG9000-RACK	Rackmount slides and rails kit for SPG9000 (1 RU height, standard full depth)
SPG9000-XLR	Adapter cable (6 feet long) from 15-pin D-sub GPI/LTC connector on the SPG9000 to 4 XLR male connectors (for LTC input/outputs) and 3 BNC male connectors (for General Purpose Interface input/outputs)

SFP Modules

Option Code	Description
SPG9000-SFP-1GESR	Gigabit Ethernet short reach 850 nm SFP transceiver module
SPG9000-SFP-10GESR	10G Ethernet short reach 850 nm SFP+ transceiver module
SPG9000-SFP-10GELR	10G Ethernet long reach 1310 nm SFP+ transceiver module
SPG9000-SFP-25GESR	25G Ethernet short reach 850 nm SFP28 transceiver module
SPG9000-SFP-25GELR	25G Ethernet long reach 1310 nm SFP28 transceiver module

Ordering Information

Power Options

Option Code	Description
SPG9000-SPW	Includes a single hot-swappable power supply
SPG9000-DPW	Includes two hot-swappable power supply modules for a redundant (primary + backup) pair

Power Cords

Option Code	Description
PWR-CORD-NA-S15	North America Power Cord, Straight 15A
PWR-CORD-EURO	Universal EURO Power Cord
PWR-CORD-CHN	China Power Cord
PWR-CORD-IND	India Power Cord
PWR-CORD-AUS	Australia Power Cord
PWR-CORD-UK	United Kingdom Power Cord
PWR-CORD-BRZ	Brazil Power Cord
PWR-CORD-CHE	Switzerland Power Cord
PWR-CORD-JPN	Japan Power Cord
PWR-CORD-NONE	No Power Cord or AC Adapter

Service Options

Option Code	Description
SPG9000 R3	Standard Warranty Extended to 3 Years. Covers parts, labor and 2-day shipping within country. Guarantees faster repair time than without coverage. All repairs include performance verification and updates. Hassle free - a single call starts the process
SPG9000 R5	Standard Warranty Extended to 5 Years. Covers parts, labor and 2-day shipping within country. Guarantees faster repair time than without coverage. All repairs include performance verification and updates. Hassle free - a single call starts the process

Ordering Information

Standalone Accessories

The DPW, RACK and XLR accessories can be ordered at the same time as the base SPG9000 product (see “Accessory Options” above) and shipped together in the same packaging, or they can be ordered separately and shipped in individual packaging. The ANT accessory is only shipped in separate packaging.

Product Code	Description
SPG9000-ACC-ANT	Multi-GNSS (GPS, GLONASS, Galileo, BeiDou) dual-band (L1 & L5) rooftop antenna that works with the integrated GNSS receiver of the SPG9000 with option SPG9000-GNSS. Includes mounting bracket. Coaxial cable with type-N connector required.
SPG9000-ACC-DPW	Hot-swappable, redundant (backup) power supply for the SPG9000
SPG9000-ACC-RACK	Rackmount slides and rails kit for SPG9000 (1 RU height, standard full depth)
SPG9000-ACC-XLR	Adapter cable (6 feet long) from 15-pin D-sub GPI/LTC connector on the SPG9000 to 4 XLR male connectors (for LTC input/outputs) and 3 BNC male connectors (for General Purpose Interface input/outputs)

Post-Purchase License Upgrades

The licensed feature options for the SPG9000 can be ordered at any time after the initial base unit purchase. No hardware upgrades are necessary to enable these features.

Product Code	Description
SPG9000-LICENSE	Upgrade license(s) to enable features for the SPG9000

Option Code	Description
SPG9000-LIC-GNSS	License; SPG9000, Enable internal GNSS receiver and time synchronization features
SPG9000-LIC-PTP	License; SPG9000, Enable PTP (IEEE 1588) support on two ports
SPG9000-LIC-SDI	License; SPG9000, Enable SD/HD/UHD test signal generation on four SDI outputs
SPG9000-LIC-IP	License; SPG9000, Enable ST 2110 test signal generation on two IP ports
SPG9000-LIC-TSG	License; SPG9000, Includes both SDI and IP licenses for test signal generation